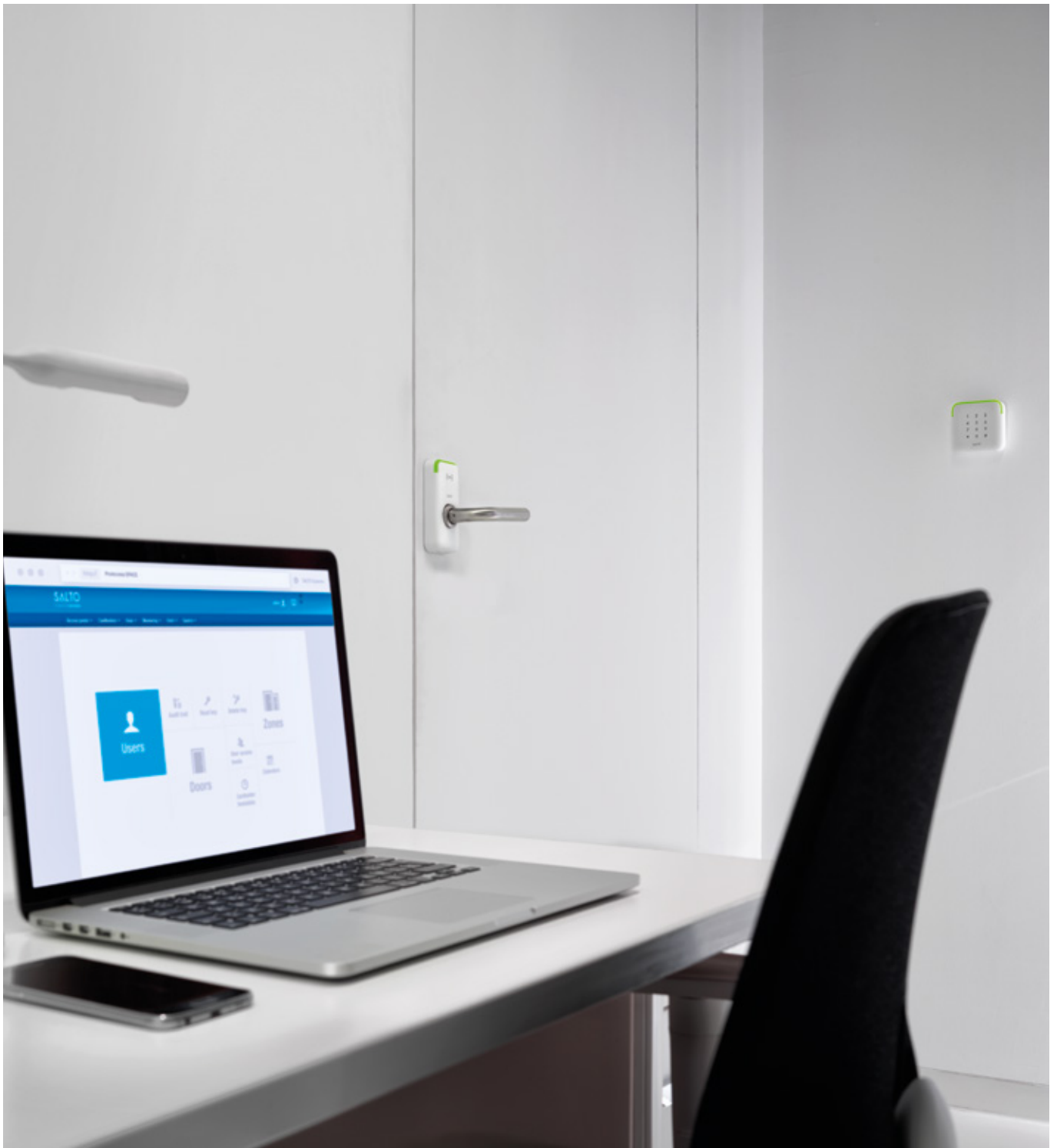

PRODUCT BROCHURE

Guided by our insights into customer needs, we deliver industry leading, next-generation electronic locking solutions without wires and without mechanical keys.

Welcome to the access, Welcome to SALTO Systems.

www.saltosystems.com

SALTO
inspiredaccess



NEXT GENERATION KEYLESS ACCESS CONTROL



SALTO SYSTEMS ONE JUMP AHEAD

Since 2001, SALTO Systems has been delivering state-of-the-art wire-free and keyless electronic access control solutions. SALTO is driven by continuous improvement and is committed to developing the most technologically-advanced and flexible electronic locking solutions for any kind of door and user need. SALTO has established itself as a global market leader in electronic access control solutions.

SALTO continues to grow the value of its brand, and today, SALTO is synonymous with innovative solutions that set new standards in security, manageability, flexibility and design that bring real-world benefits.

The pioneering SALTO Virtual Network SVN data-on-card and technology platforms provide stand-alone, smart locking solutions that continue to set SALTO apart. More recently, the company's technological expertise has brought SALTO to leading positions in both cloud-based access control technology and mobile access solutions.

Having revolutionized access control in a vast number of industries and applications – from office, education, healthcare, transport and commercial buildings to business, hospitality and residential – SALTO continues to deliver industry-leading electronic locking solutions to markets across the globe.

SALTO

Customer Solutions	4
Access Control Benefits	6
TECHNOLOGY PLATFORMS	8
SALTO SPACE	10
SALTO RFID Scalable (ROM)	12
SALTO Virtual Network (SVN)	14
SALTO BLUEnet Wireless	16
SALTO Online Network (SVN)	18
SALTO JustIN Mobile Solutions	20
SALLIS - Integrations	22
SALTO KS	24
SALTO KS - Keys as a Service -	26
SALTO KSconnect	28
XS4 PLATFORM	30
XS4 Electronic Escutcheons	30
XS4 Mini Electronic Door Locks	52
ÆElement	64
SALTO GEO Electronic Cylinders	84
Wall Readers	104
Vehicle Access	118
Control Units (CUs)	122
XS4 Locker Locks	132
XS4 Panic Bar Solutions	136
Mortise Locks	142
SALTO SPACE PLATFORM PERIPHERALS	154
Wireless System Peripherals	156
Energy Saving Devices (ESD)	157
Access Control Management Tools	158
Credentials	160
SALTO SPACE PLATFORM SOFTWARE	162
ProAccess SPACE	164
Hospitality Add-ons	170
SALTO KS PLATFORM COMPONENTS	172
SALTO KS IQ	174
SALTO KS Tags	175
SALTO KS App	176
SALTO KS Web-App	176
SALTO KS CONNECT	178
Camera Manager	179
COMPANY PROFILE	182
Contact	184

CUSTOMER SOLUTIONS

SALTO access control solutions are in use worldwide in a never-ending range of challenging and unique applications and facilities.

Core markets include commercial and manufacturing environments, public institutions, healthcare facilities of all types, educational settings and campuses, transport installations, leisure facilities, as well as the hospitality sector. SALTO solutions cover so many projects in so many markets due to the scalability of the system -- smaller projects can be implemented and then as required easily expand to larger, even transnational solutions.



COMMERCIAL

SALTO solutions are in use around the world in many types of commercial buildings, where they provide security, access control and staff and workforce management.

- Office & Industrial buildings
- Transportation
- Government
- Sport facilities
- Hospitality

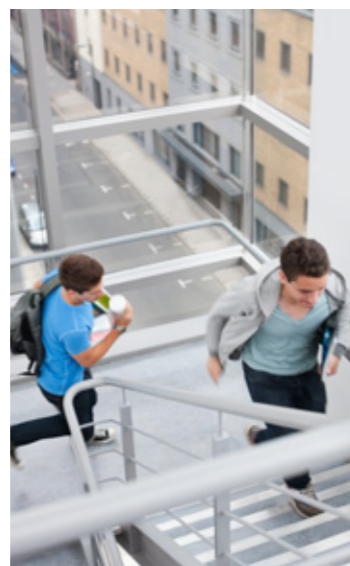

EDUCATION

Security measures in universities, colleges and schools need to be robust and effective but unobtrusive. Parents need to trust educational institutions to look after their children, so it is vital that they provide effective 24/7 security and ensure both students and staff are safe and protected at all times.

- Universities
- Schools
- Student housing



HEALTHCARE

Smart access control technology platform designed to give users ultimate freedom of choice regarding system layout, type and number of access points as well as level of security for healthcare environments.

- Hospitals
- Assisted living
- Home care



RETAIL / COWORKING

SALTO solutions make access control a simple and secure solution for business access to manage keys, users and doors across multiple locations to ensure that only the right people get through.

- Retail
- Coworking spaces



HOSPITALITY

SALTO's broad product range covers every aspect of the access control spectrum, from back-of-house, guest services doors, to guest room doors management.

An access control system for the hospitality sector with unprecedented flexibility.



RESIDENTIAL

Smart locks replace the traditional home door key with an electronic system that allows you to use your smartphone to control your door, your guests and your home.

- Residential / Home living
- Multi-family housing
- Rental properties / Apartments

THE BENEFITS OF A SALTO SOLUTION

Inspiration, dedication and passion have led SALTO to become one of the world's top five manufacturers of electronic access control systems in little more than 10 years.

SALTO brings you more

Security

Provide seamless keyless experiences, with patented and fast read and write data-on-card technology, expertise in applying wireless electronic locking solutions in the most secure way.



Works with all popular smart keycards covering the mainstream RFID technologies.

Compatible with leading physical security information management systems (PSIM).

Reliable products due to extensive in-house R&D, in-house production and in-house quality management.

SALTO brings you more

Design

Complete hardware and software platform, which fits virtually any door and any access point and suits all vertical markets.



Open architecture and standardized interfaces allow seamless integration.

Future-proof scalability.

Longest in-depth knowledge of virtual network technology.

Integration of legacy credentials, and compatibility with other systems through multi-application.

Market-driven development.

SALTO brings you more

Flexibility

Mechanical key management is costly, unsecure and a hassle. Upfront costs of replacing master keys, drilling out locks, updating all affected users' keys, plus indirect costs like maintenance team productivity can be substantial.



Cost-saving maintenance of door components.

Maximized ROI through buy-once philosophy.

Upfront investment is substantially less than with traditional wired access control solutions.

SALTO hardware is designed to cost-effectively meet international wireless technology standards.

SALTO brings you more

Manageability

Effective and time-saving management of all online, offline and wireless access points and applications in one software package.



Different applications apart from doors can be included.

Systems architecture structured around users and doors, easy navigation, user-friendly management.

Multi-application allows one credential to be used for different applications.

Update the access plan quickly, easily and securely.

WITH SALTO, SAY GOODBYE TO MECHANICAL KEYS

THE ACCESS CONTROL SOLUTION YOU THOUGHT YOU'D NEVER FIND

At SALTO, our goal is to always give our customers the products they need to meet and surpass the challenges they face. It's why we go the extra mile to design and manufacture innovative access control solutions using the latest technologies in order to meet users' needs and any type of building requirements both now and in the future—whatever the market.



SALTO Systems revolutionized access control with the introduction of the SALTO Virtual Network SVN data-on-card technology and the battery-operated wire-free electronic lock range in 2001. For nearly 20 years SALTO has been synonymous with innovative solutions, including stand-alone, cloud-based and mobile applications, that set new standards in security, manageability, flexibility and design that bring real-world benefits to virtually any type of door. SALTO is widely recognized as a global market leader in electronic access control solutions across a broad range of industries and applications.

Today, SALTO leads access control innovation with the development of and continued investment in SALTO SPACE networked wire-free battery-powered locks and SALTO KS cloud-based technology platforms.

SALTO SPACE

WIRE-FREE SMART ACCESS CONTROL TECHNOLOGY PLATFORM.



SALTO's SPACE networked electronic locking access control platform brings a new level of powerful flexibility to access control so that users can order the functionalities they most need and upgrade accordingly as a system and needs grow.

SALTO SPACE access control management platform offers a modern, user-centered interface web-based software for varying skills, capabilities, and security levels. Mobile access control adds convenience and flexibility without sacrificing security.

SALTO KS

CLOUD-BASED ACCESS CONTROL, ON-THE-GO AND IN REAL-TIME.

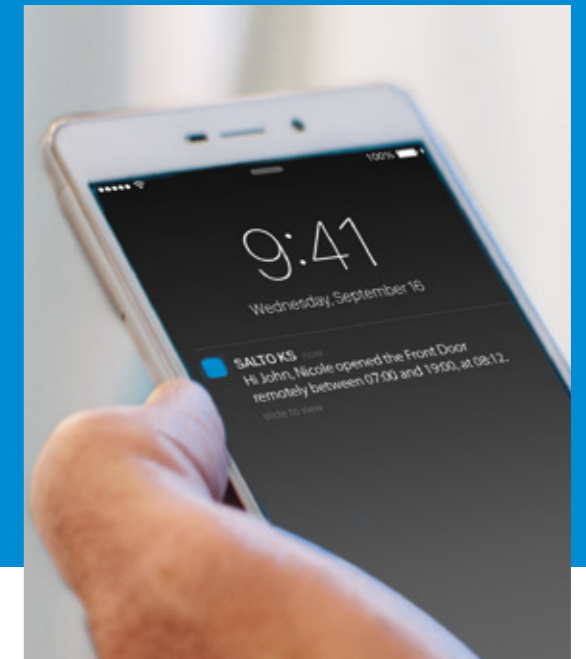

SALTO KS - Keys as a Service - provides a flexible, cloud-based access control management system that requires no software installation or the added expense of a fully-wired electronic product. All that is needed is an online device with an Internet connection.

SALTO SPACE

WIRE-FREE SMART ACCESS CONTROL TECHNOLOGY PLATFORM



DIFFERENT BUILDING TYPES HAVE DIFFERENT SECURITY NEEDS

SALTO offers a wide range of technologies and system layouts. From a highly capable mid-range ROM system up to the data-on-card SALTO Virtual Network (SVN) system and the wireless online (BLUEnet) system, SALTO has what end users need.

Upgrade anytime - whenever required - and even mix and match several technologies such as SVN and BLUEnet Wireless.

SALTO's SPACE access control technology platform is designed to give end users ultimate freedom of choice regarding system layout, type and number of access points as well as level of security. In addition, SALTO easily adapts to changing requirements and can deliver scalability no matter what the project size.

Having one of the broadest product portfolios in access control worldwide, SALTO SPACE can fulfill virtually every technical and functional requirement. Thus, access control solutions by SALTO can encompass almost every access point in a building and its perimeter.

PROACCESS SPACE MANAGEMENT SOFTWARE:

Intuitive user-centered web-based software interface that makes it simple and secure to incorporate access control for any type of building size or user needs. It's a powerful and flexible software allowing each system operator to set up their own preferences: capabilities and security level, language settings and others.

SALTO's SPACE platform offers several ways to integrate with third-party systems. This includes interfaces and APIs for connecting SALTO smart lock technology to video surveillance, vehicle access, biometrics, time & attendance, escape door control systems, intrusion alarm, and many more.





ROM SCALABLE SYSTEM RFID TECHNOLOGY

YOU CHOOSE THE LEVEL OF SECURITY CONTROL YOU NEED

SALTO Systems' unique new networked escutcheons and cylinders can be used for an extensive range of access control applications. It's the first RFID system that can be upgraded at any time.

It provides all the benefits of a stand-alone access control system in a compact, cost effective package for user, key and door management for small installations.

Through an easy-to-use software you can create keys, users and doors, user groups and zones, and set time periods and opening modes that instruct the door to lock or unlock automatically as needed.

SALTO has the options you need for the right solution now and can easily grow with you as your needs change in the future.

MAIN FEATURES AND BENEFITS

Computer managed, allowing for the configuration of the electronic escutcheons, monitoring of access flows, recording access, adding and removing users and setting up the user access profile.

Simple & secure system for key management. The system can manage up to 16,000 users and 65,000 doors.

7 different opening modes to suit your needs (standard, free passage ability, free passage with automatic locking, automatic opening, toggle and timed toggle).

30 time zones, 4 calendars and 680 door events held in the electronic escutcheon/electronic cylinder memory.

Scalability, flexibility and functionality. The system can be upgraded simply by using a Portable Programming Device (PPD), making it possible to upgrade to a data-on-card SVN system when your needs change.

Multi-application through the contactless carrier enables use of existing contactless RFID smart cards.

HOW IT WORKS

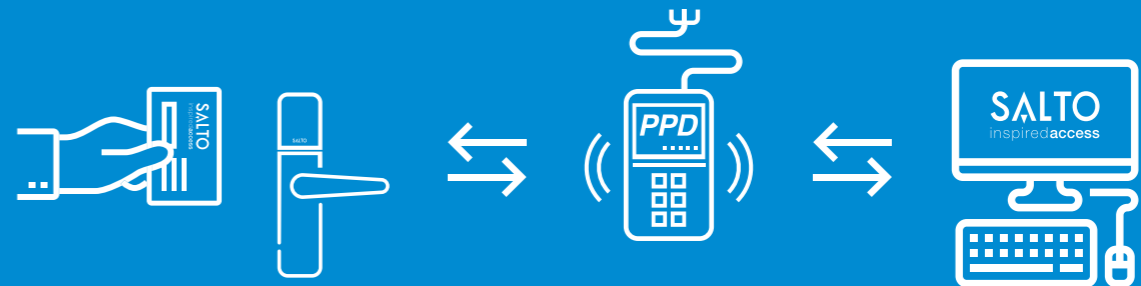

Stand-alone electronic lock:

Any changes you make such as: adding new users, deleting users, updating the escutcheons, electronic cylinders or wall reader, or collecting the event audit trail are done through its ProAccess ROM software and contactless PPD.

Contactless Portable Programming Device (PPD):

Each time you connect the PPD to an escutcheon, electronic cylinder or wall reader, the event audit trail and battery status will be automatically downloaded.

ProAccess ROM functions:

- Add or delete users
- Set up user profiles (calendars, shifts, etc.)
- Change escutcheon opening modes
- Event audit trail
- Stand-alone locks battery status remote report



SALTO VIRTUAL NETWORK (SVN) DATA-ON-CARD TECHNOLOGY

STAND-ALONE NETWORKED LOCKING SYSTEM

The SALTO VIRTUAL NETWORK (SVN) is an easy-to-use system that integrates all physical security needs through networked, stand-alone, battery-operated smart locks. The SVN platform provides the most up-to-date user access information for virtually all doors in a facility.

This innovative, wire-free technology allows stand-alone electronic escutcheons to read, store and write information via its operating smart cards. This data is captured from the user's key at wireless networked electronic locks / cylinders (There are no restrictions, any door serves as a hotspot. SVN-Flex functionality can be enabled on new SALTO latest generation electronic lock) or online IP SVN access points located at strategic points around the building.

The "updating access points" download and revalidate user-related access plan information that is then used to permit or deny access.

Manage and secure access control for all of your facilities right from your desk. Check battery status (to optimize maintenance) and user event information in just a few easy steps.

MAIN FEATURES AND BENEFITS

Cost-effective, quick and easy installation to upgrade the traditional mechanical key-operated door locks without having to replace the door and with no hardwiring required.

Enhances security for any type of doors, eliminating key management issues and user authorization changes in real-time from any access point.

SVN-Flex: Update and modify user access rights from any defined access point. Eliminates the need for users to go to specific doors to update / revalidate their expired key or change their access plan.

Control and manage all stand-alone access points remotely from one or more workstations.

Easy maintenance, battery low warning sent for maintenance.

More than 10 different opening modes to suit your needs.

SECURE

- In case of a power failure, the system keeps functioning because it's a stand-alone electronic locking system.
- Emergency openings can be performed through the PPD.
- Communication between the carrier, the physical network and the electronic door lock are encrypted and secured.

HOW IT WORKS



User key transmits to electronic lock / reader:

- Deleted cards list
- User access rights

Electronic lock / reader transmits to user key:

- Access event
- Battery status

User key transmits to the system via SVN:

- User access event
- Visited door battery status
- Deleted cards list
- User access rights

Electronic lock / reader transmits to card / user key:

- Deleted card list
- Updated user access rights
- Expiry date renovation

ProAccess SPACE functions:

- Add or delete users remotely
- User profiles updated easily
- Dynamic event audit trail
- Remote stand-alone device battery status report
- Expiry date renovation

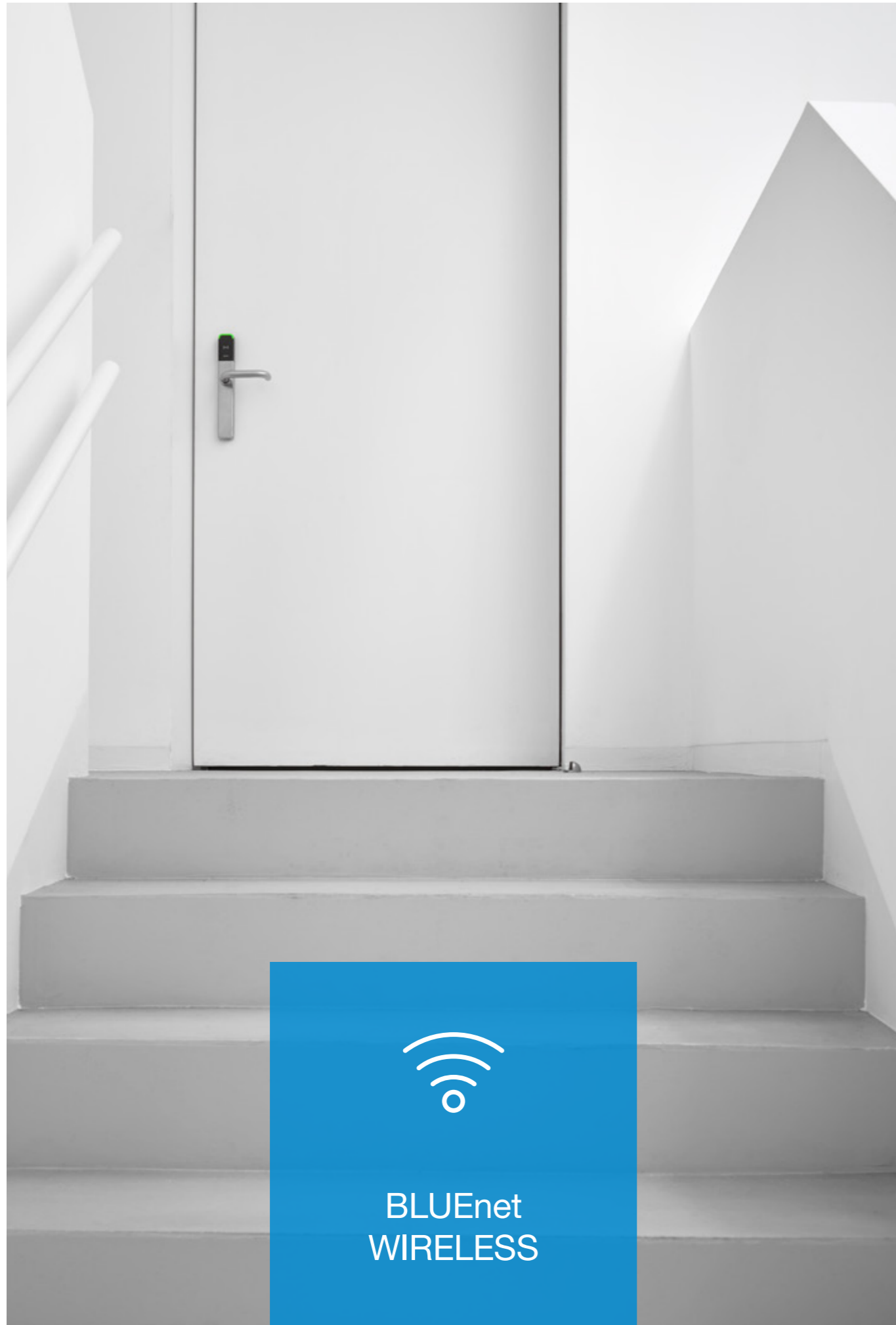

SALTO BLUEnet WIRELESS REAL-TIME TECHNOLOGY

FLEXIBLE AND SECURE REAL-TIME MANAGEMENT

SALTO BLUEnet Wireless has been developed to meet the highest demands related to security and ease. This access control system is networked through Bluetooth RF and is especially designed for doors where real-time control is required.

A wireless access control solution based on the SALTO BLUEnet wireless communication permits electronic locks to update the user's keys and to provide real-time door monitoring. This enhances the performance and capabilities of the SALTO Virtual Network.

An access control technology that allows stand-alone SALTO BLUEnet wireless locks to update, store and send the latest access information from the user's smart keys throughout the building wirelessly and remotely.

SALTO BLUEnet can be installed as an independent system or can complement SALTO Virtual Network (SVN) in areas of a building where real-time control is required.

MAIN FEATURES AND BENEFITS

Wireless electronic locks provide better cost, convenience and aesthetics than a wired solution, achieving wired system benefits without the cost of hardwired systems.

If radio frequency is interrupted or breaks down, the access system will continue to work, as the virtual network of the battery-operated locks remains operational through SALTO SVN.

Wireless network communication architecture: One gateway can communicate with 7 nodes. Each node can operate up to 16 doors, with a maximum distance of 16m between the lock and the node. All by using one single IP address.

Designed for easy integration into existing access control systems, SALTO BLUEnet Gateways, Nodes and Repeaters connect to the system using Ethernet connectivity.

ADVANCED FEATURES AND FUNCTIONS

- Advanced security with standard encryption communications.
- Escutcheons and cylinders receive blacklist information and remove cancelled keys from the system in real-time.
- Receive audit trail information in real-time.
- Real-time door control: This includes door alarm, intrusion alarm, single lockdown and remote door opening.
- Real-time battery control enables maintenance to view escutcheon power status in real-time.

HOW IT WORKS

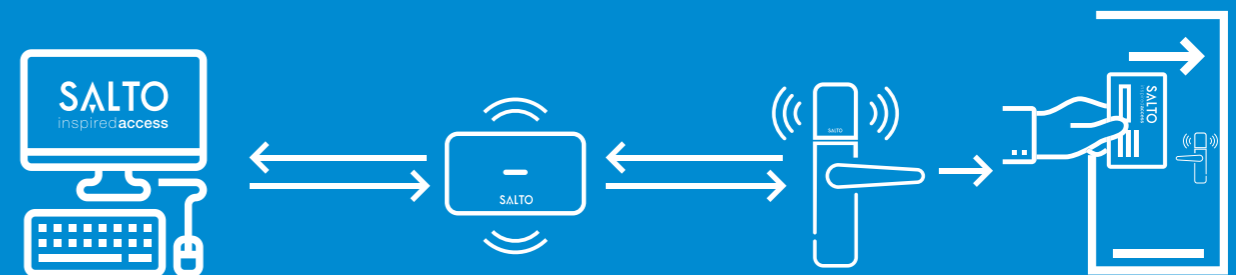

ProAccess SPACE functions:

- Access event
- Key cancellation
- Door monitoring
- Graphical mapping
- Battery status
- Remote emergency opening
- Lockdown in case of emergency situation
- Opening function mode

Gateway transmits to cylinder/escutcheon:

- Deleted card list
- Updates to the escutcheon or cylinder

Electronic lock / cylinder transmits to gateway:

- Access event
- Battery status
- Intrusions alarm



SALTO VIRTUAL NETWORK (SVN) ONLINE NETWORKED TECHNOLOGY

ONLINE NETWORKED LOCKING SYSTEM

The SALTO Virtual Network (SVN) online networked locking system is a state-of-the-art IP-based access control solution for applications requiring high levels of security.

The exchange of information via a user's contactless smart key and online access points is secured and encrypted. The online SVN is a data-on-card system based on a patented read/write technology. In SVN, all user-related access information is stored on ID credentials which act as carriers. The access rights are updated at hardwired online IP access points.

Advanced online features such as monitoring your building's graphical map, IP reader integration (long distance reader for vehicle access, fire alarm systems, biometric access control readers, etc.), trigger an alarm event engine module to further extend the advanced capabilities of the SALTO cutting-edge online access control system.

MAIN FEATURES AND BENEFITS

Reliable, high quality systems: Update straight away user's access permissions and access levels at the click of a button.

Architecture designed to adapt and grow with your needs: Control any type of building application, from just one door up to hundreds of doors, with thousands of users.

Control and manage multiple doors through one Ethernet connection, operate up to 4 auxiliary online controllers and up to 10 access points with a single IP address.

Event reporting: Online real-time audit trail showing who is where and when. Monitor all your users, staff and visitor movements on site, from your computer.

Link with your security systems: Easy-to-extend security beyond door control. You can integrate biometric or vehicle access readers, fire alarm systems or third-party security systems directly to your access control system.

Email and text alerts can be set up to alert you if a specific event has occurred.

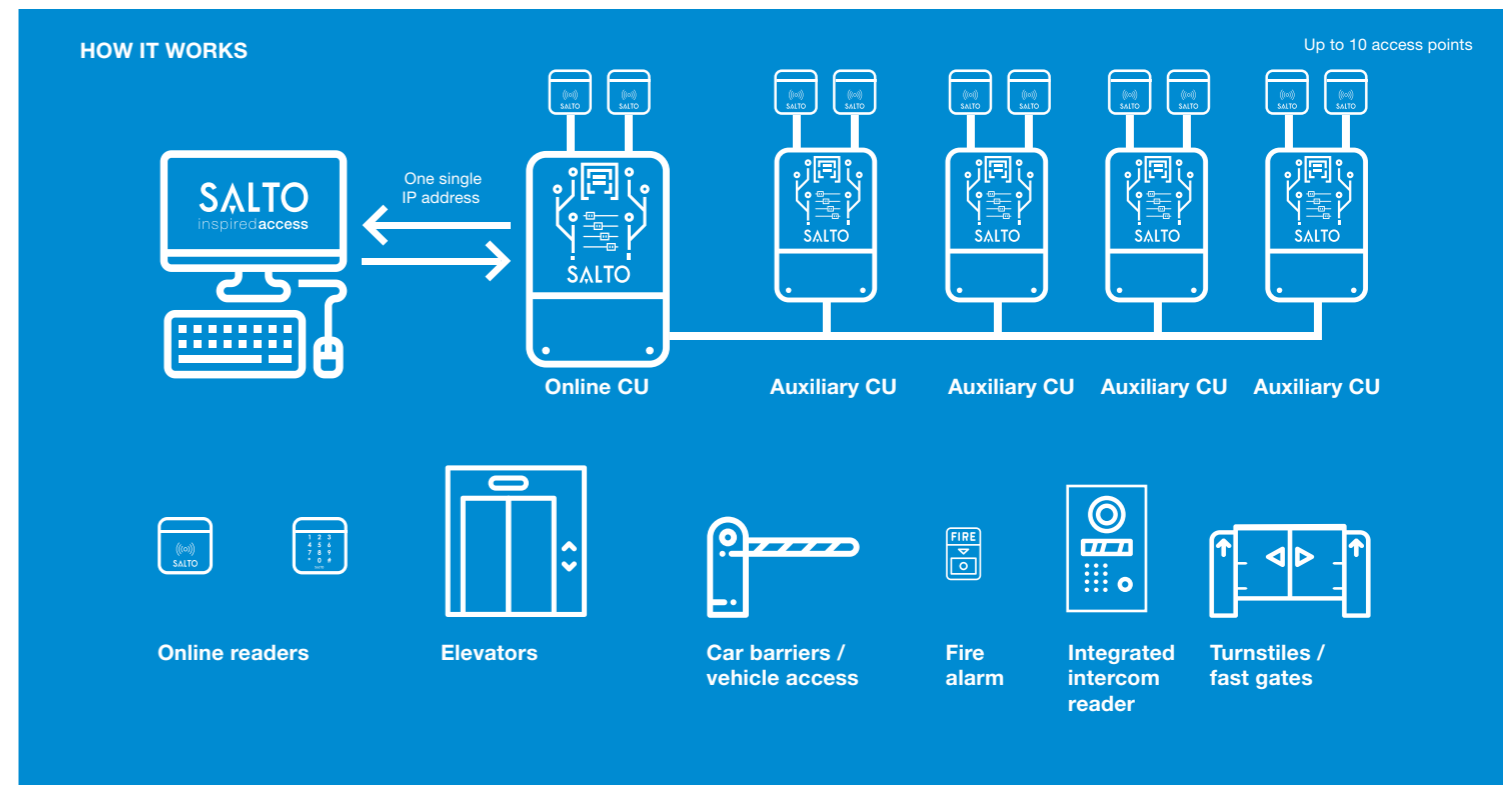



SALTO JustIN MOBILE MOBILE ACCESS TECHNOLOGY

MOBILE-BASED ACCESS CONTROL SOLUTION - BLE & NFC

SALTO's JustIN mobile technology makes it easy and secure to incorporate smartphones as a part of your access control solution. Using SALTO's JustIN technology, these solutions easily and flexibly bring better security and usability to both end users and system managers. End users gain convenience and productivity without sacrificing security, while facility managers distinguish their property with cost-effective solutions that clients truly value.

MAIN FEATURES AND BENEFITS

Use mobile phone as a door key. Access control systems compatible with NFC, BLE and RFID ID technologies.

USER FRIENDLY

- End user decides how to receive a key: as a JustIN Mobile or as a physical credential.
- Extend access or change access rights instantly and remotely.
- Works with a user's existing iOS or Android smartphone.
- JustIN Mobile app lets an end user receive their key online.

SECURE

- Smartphone authentication technology for verifying a mobile user's identity: PIN / Fingerprint.
- AES 128 bit encryption and secure opening procedure with key received securely encrypted using SSL.
- Instant key updates or key cancellations.
- Real-time access rights changes, audit trails, and blacklisting lost keys.
- For a higher security level, no information is stored in the SALTO JustIN cloud, used only as a temporary bridge.

SDK

iOS and Android software development kit (SDK) for the development of apps for JustIN Mobile access operating technology to make it easy and secure to incorporate smartphones as a part of your access control solution.

HOW IT WORKS



ProAccess SPACE functions:

New access rights given by system administrator.



OTA:

Users receive their keys OTA (Over the Air), anytime and anywhere at a registered and verified smartphone.



JustIN Mobile App:

Users utilize their smartphones to select and open the door. All data transmission and the mobile key itself are encrypted and secured against cloning.



BLE & NFC-enabled stand-alone electronic lock / cylinder:

The app sends lock audit trail and low battery status monitoring for maintenance-needed operations.

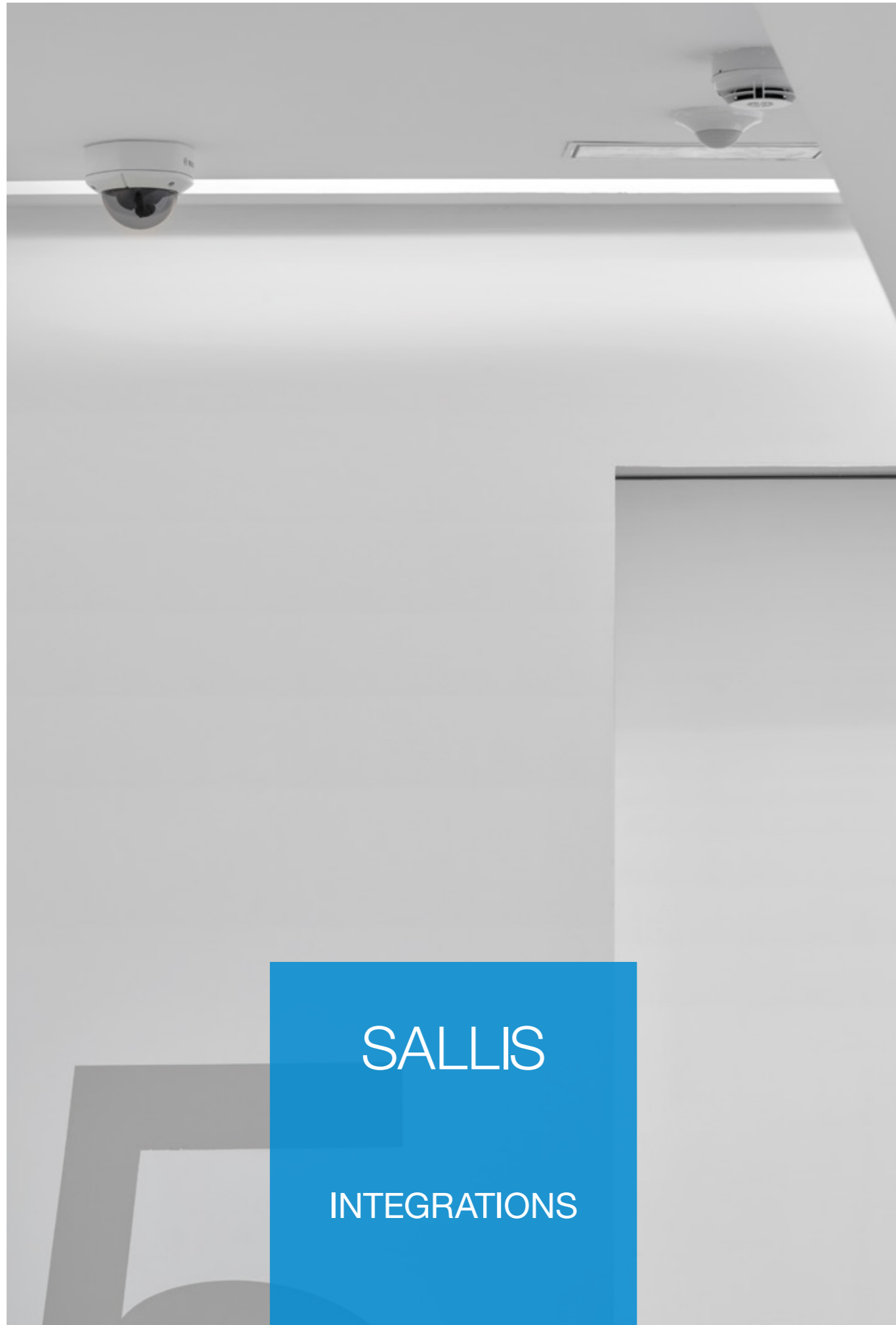

SALTO SALLIS

SEAMLESS COMBINATION OF DIFFERENT SECURITY SYSTEMS

In many security installations, there is a need for combining systems by different vendors. SALTO offers several ways to integrate with third-party products. This includes interfaces for connecting SALTO to third-party wired access control systems as well as integration with video surveillance, parking management, license/number plate recognition, biometrics, time & attendance, escape door control systems, Physical Security Information Management Systems (PSIMs), training systems for safety instructions and much more.

MAIN FEATURES AND BENEFITS

Completely compatible with the SALTO XS4 wireless escutcheon range.

Powerful diagnosis tool thanks to over 25 different event codes within the audit trail.

Based on audit trail: When lock is offline, lock will grant access to the user according to their last user event within the lock. For high transit doors.

Based on white list system: Up to 20 master keys subject to time zones can be stored in the lock memory. With proper set up, no door will be left without control. 600 audit trail events are stored on the lock, regardless of the state of the communication with the host.

ADDITIONAL FEATURES AND FUNCTIONS:

- Wireless communication AES 128 bit encryption.
- Wireless communication at 2.4ghz based on IEEE 802.15.4.
- Online audit trail and battery status control.
- Live door monitoring.
- 20 emergency codes subject to time zones.

HOW IT WORKS

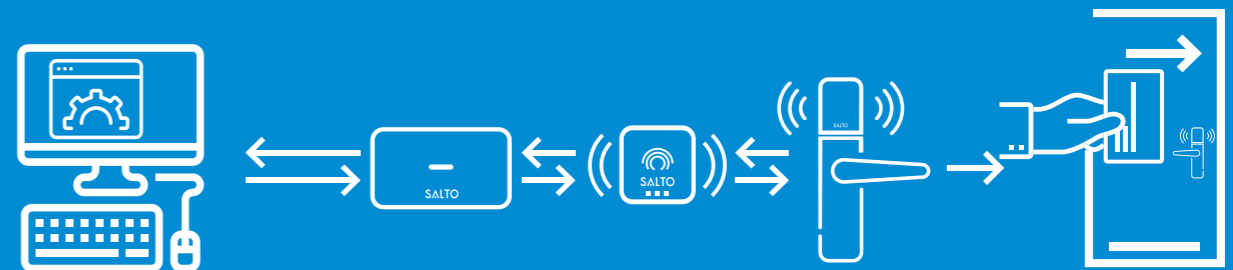

HOST & database:

The HOST is the access control panel where the information related to access is hosted (users, time periods, calendars, etc.).

Router:

The SALLIS Routers and Nodes are the link between the host and the rest of the platform and enable communication with the wireless escutcheons and cylinders.

Node:

SALLIS electronic lock / cylinder :

The wireless locking devices are the core of the locking system itself and enable control of doors without need for complex wiring installations.

SALTO KS KEYS AS A SERVICE

CLOUD-BASED ACCESS CONTROL, ON-THE-GO AND IN REAL TIME



SALTO KS - Keys a a Service - makes access control a simple and secure solution for businesses to manage keys, users and doors across multiple locations.

No software installation, scaling on any device, secured login, intuitive design - anything you may expect from today's cloud is in the SALTO solution.

SALTO customers do not need to worry about any door running out of capacity, as SALTO KS is effectively infinite in size. The solution also incorporates state-of-the-art security measures in all components and, more importantly, to keep updating that permanently. Not always visible but always there. Manage locks, people, messages and important access rights with no hassle.

www.saltoks.com



SALTO KEYS AS A SERVICE

The SALTO KS cloud-based access control platform allows you to control all of your locations and access needs from anywhere. Vastly better functionality and performance than a mechanical solution. Flexible, with no software installation required.



SALTO KS CONNECT

KS Connect allows SALTO KS customers to integrate with existing software applications which streamlines operations and maximizes technology. KS Connect enables third-party software and service providers to enrich offerings with smart-lock functionality.



EASY ACCESS CONTROL FOR YOUR BUSINESS

With SALTO KS there's no need to install software or there's no need to replace a lock if keys are lost or stolen. Managing doors, keys and user access levels has never been easier and more secure; simply block a user key.

SALTO KS is an easy-to-use and simple-to-manage access control dashboard that supports your business needs for a modern physical access control solution that gets all doors online and unifies access with a single cloud solution.

MANAGE AND MONITOR PHYSICAL ACCESS IN THE CLOUD

SALTO KS allows you to individually define who can enter which doors during which time periods.

What no conventional key can do is change access rights on the fly. The SaltoKS.com website portal gives you the opportunity to quickly and easily determine who enters a property and when. If changes need to be made, then just log in, make the change, and it's done. No updating of the SALTO KS Tag or SALTO KS access point is necessary. Can you do this with your current lock?



SALTO KS KEYS AS A SERVICE

FROM WHEREVER YOU ARE - REGARDLESS OF WHERE YOUR BUSINESS IS

SALTO KS has established proven reliability and its recognised stability brings cloud access control to any business, providing vastly better functionality and performance than is possible in a traditional mechanical solution. A flexible management system that requires no software installation, nor the cost of a fully-wired electronic product; the only item you need to manage SALTO KS is an online device with an Internet connection.

MAIN FEATURES AND BENEFITS

Open doors remotely. With SALTO KS “Code,” SALTO KS’ one-time password technology, users can open doors remotely without a key. One of the cool but functional features of SALTO KS is the remote access.

Gain activity insights. Receive notifications regarding door and user activity. Saltoks.com provides a message center that allows users to self-configure messages. For example, learn who entered at what time, or when a door is left open. Messages can be configured to be sent to a number of recipients and to three receiving device types: Email, SMS and App push notifications.

Multiplatform. Manage SALTO KS from any device – phone, tablet, PC – all you need is an online device with an Internet connection.

Security. With SALTO KS App “Code,” SALTO KS’ one-time password technology, the system makes sure users have proper rights to perform changes.

HOW IT WORKS

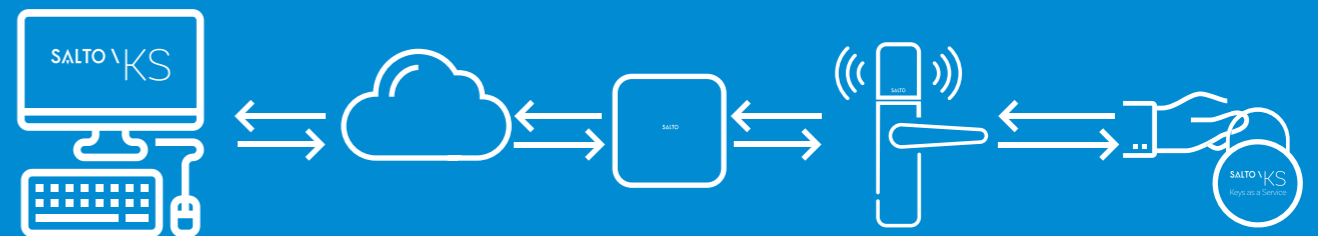

SaltoKS.com and Mobile App:

Your portal to your account, where you can create access groups, manage users and view entries to your properties from your computer or mobile devices.

IQ:

The IQ is the hub of the SALTO KS solution. Finds the best connectivity to communicate with SALTO KS locks and SALTO KS apps.

Door Locks:

The SALTO KS escutcheons & cylinders are specially designed to fit different profile doors, even narrow profile framed doors, and can be applied on exterior doors as well. SALTO offers a wide range of finishes to choose from.

Tag:

An RFID tag that makes keys a thing of the past. The tag triggers the lock to engage within seconds so visitors or employees can enter easily and according to access rights.



SALTO KSconnect

CLOUD CONNECTED SERVICE PLATFORM

SALTO KSconnect offers a platform where future partners can find integrated cloud-based software and services.

SALTO has developed an ecosystem of cloud applications where future partners and services can be integrated. The result is a world of possibilities for service and hardware integration.

KSconnect allows SALTO KS customers to have integrations with existing software to run their business with ease. KS Connect enables third-party software and service providers to enrich offerings with smart lock functionality, as well as enhance the SALTO KS value proposition.

CAMERAMANAGER

Eagle Eye CameraManager is built for the cloud, providing reliability and redundancy. It's ideal for servicing multiple locations and provides access to live and recorded video, from one or more locations, with a single login. Eagle Eye CameraManager is also fully integrated into SALTO KS applications.

- **Easy set-up:** Add cameras in two steps.
- **Scheduling:** Record when needed.
- **Notifications:** Know what's up.
- **Live Streaming:** See who's in front of the door.
- **Event Recordings:** Look back in time.

HOW IT WORKS

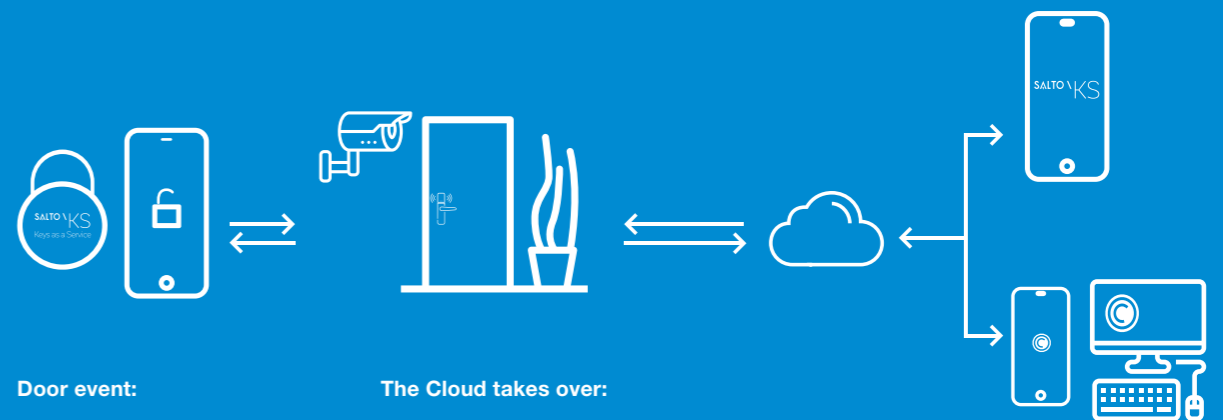

Door event:

Any event happening with a door - a door opening, for example - which has previously been linked to a camera will be reported.

The Cloud takes over:

The SALTO KS Event - for example, Samuel has opened the Main Door at 13:34 via Remote - is stored in the cloud with video.

KS **SALTO KS App**
With integrated video stream and event view.

CameraManager Apps
Show door events, motion detection, and sound detection.



XS4 Escutcheons

XS4 FOR EUROPEAN MORTISE LOCKS

- XS4 EU Standard
- XS4 EU DIN Standard
- XS4 EU with Keypad
- XS4 SKG**
- XS4 Security
- XS4 Double Reader

XS4 FOR SCANDINAVIAN MORTISE LOCKS

- XS4 Nordic Standard
- XS4 Nordic Security
- XS4 Nordic with Keypad

XS4 FOR ANSI MORTISE LOCKS

- XS4 ANSI Standard
- XS4 ANSI with Keypad

XS4 FOR GLASS DOORS

REFERENCE GUIDE

- Handles
- Finishes
- Models

XS4 BY SALTO | ELECTRONIC ESCUTCHEONS

Smart, secure, innovative and easy to install, the XS4 electronic escutcheon sets need no hard wiring and provide a totally wire-free networked electronic locking solution with a great range of features.

TECHNICAL DATA

POWER SOURCE:

- XS4-40 narrow version: 3 alkaline batteries (LR03 - AAA 1,5V).^(*)
Optional 3 Lithium batteries (FR03 - AAA 1,5V - see environmental conditions).^(*)
- XS4-60 wide version: 3 alkaline LR6 AA 1,5V. batteries.^(*)
Optional FR6 - AA1,5V. Lithium batteries.^(*)

NUMBER OF OPENINGS:

- i-Button version: up to 60,000 on 1 set of batteries.
- Contactless versions: Up to 40,000 depending on the RFID technology.
- Low battery power indication monitored through the SALTO Virtual Network (SVN).
- The last approx. 1,000 operations are signalled.

ENVIRONMENTAL CONDITIONS:

- External escutcheon: 0° / 60°^(*)
- External escutcheon: -20° / 60°^(*)
- Internal escutcheon: -20° / 60°^(*)

MAIN FEATURES

- Simple installation by changing handle set, reliable and durable.
- SALTO SVN and SALTO Wireless network capable.
- Door status detector to monitor intrusions or door left open status (wireless escutcheons only).
- User on card audit trailing capability via the SALTO Virtual Network (SVN).
- Covering the mainstream RFID technologies.
- NFC compatible.
- All communication between the carrier and the electronic lock is encrypted and secured.
- Low battery status information is obtained from carriers.
- The lock can always be opened from the inside (single action panic feature works in conjunction with the relevant mortise lock).
- High security protection via high resistance, hardened anti-drill plates to protect wiring and reader area.
- Handle fixed by steady fix system (patented).
- Concealed fixing screws for greater security and improved aesthetics.
- Available with mechanical cylinder cut outs for key override or access lock outs.
- Wide range of finishes, handles and retrofit cover plates.
- Suitable for emergency exits.
- Firmware upgrade through PPD.
- Emergency opening via portable programming device (PPD).

The XS4 escutcheon range is specially designed to fit on most standard doors, and work with the majority of Scandinavian, European and ANSI mortise locks and tubular latches.

ACCESS CONTROL FEATURES

USERS & DOORS:

- Maximum number of users per door: 4 million.
- Maximum number of doors per system: 65,000.
- Access levels: unlimited.

CALENDARS & TIME ZONES:

- Calendars in system: 256
- Timetables: 1024
- Time periods: 1024

EVENTS:

- Maximum events on lock audit: 2200^(*).
- Non volatile memory (memory is not deleted, even if power fails).

MANAGEMENT SOFTWARE:

- SALTO ProAccess SPACE.

ID TECHNOLOGIES:

- Covering the mainstream RFID technologies.
- Compatible with ISO 14443A, ISO 14443B and ISO 15693 (Vicinity).

LOCK MODES

STANDARD:

Locked at all times.

OFFICE MODE:

Free passage.

TIMED OFFICE:

Automatic locking at end time.

AUTOMATIC OPENING:

8 pairs of "hands free" timed lock and unlocks per day with holidays.

TOGGLE:

Present card to lock, present card to unlock.

TIMED TOGGLE:

Present card to lock, present card to unlock depending on schedules.

AMOK MODE:

Local lockdown of the escutcheon for emergency situations (AMOK escutcheon models only).

EXIT LEAVES OPEN MODE:

The lock remains unlocked after the inside handle is used.

XS4 ONE - EU

XS4 EX70 | XS4 ONE EU

The SALTO XS4 One is the evolution of the Original model with a built-in, totally new reader available in two colours. This version is compatible with most European mortise locks and cylinders.



TECHNICAL CHARACTERISTICS:

- Covers door thicknesses: From 32mm up to 120mm.
- Dimensions: 285mm x 42mm x 19,5mm.
- Reversible handle left or right escutcheon.
- Clutch mechanism escutcheon; when unlocked handle moves freely.
- Handle rotation: 45°.
- Distance from the handle to the cylinder: 47mm to 110mm.
- Compatible with DIN and European mortise locks, mortise locks with Swiss profile cylinder, Australian standard mortise locks and narrow style mortise lock.
- Compatible with European profile and Swiss profile cylinders.
- Square spindles available: 7mm, 7.6mm split (Australia), 8mm, 8mm split, 9mm and 9mm split.

TECHNOLOGY PLATFORMS:



ID TECHNOLOGIES:

- MIFARE® (DESFire EV1, Plus, Ultralight C, Classic - ISO/IEC 14443).
- Bluetooth SMART (BLE).
- HID iCLASS® Seos™.
- NFC.

FEATURES:

- Simple installation is possible on any type of door, including those with narrow frames.
- Body and escutcheon made of steel.
- Available with mechanical cylinder cut outs for key override or access lock outs (override European and Cam profile cylinder) with audit trail facility available.
- Mechanical or electronic privacy option.
- The lock can always be opened from the inside (single action panic feature works in conjunction with the relevant mortise lock).
- Complementary escutcheons without reader available to maintain the aesthetics of doors that do not need to be controlled.

READER COLOUR:



FINISHES:

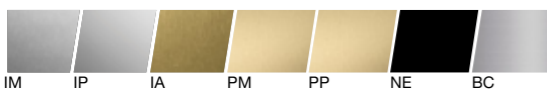

TECHNICAL DRAWING:

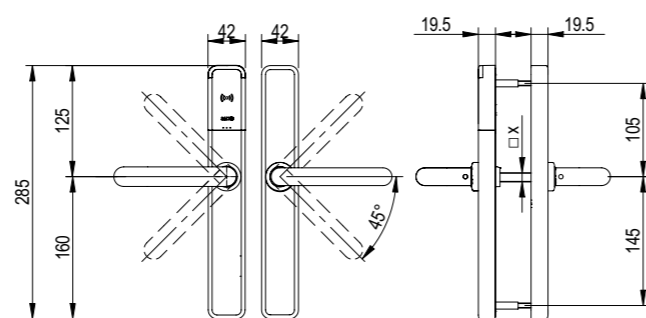

CERTIFICATIONS:

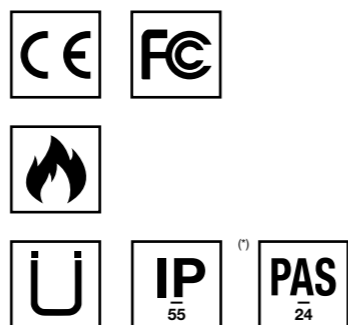

(1) External escutcheon.



XS4 ONE - DIN

EX70 | XS4 ONE DIN VERSION

The SALTO XS4 One DIN version escutcheon is specially designed to meet the requirements of DIN18250 and 18251 standard doors prepared for DIN 18250 standard mortise locks. The new escutcheon range maintains the fire rating of the door as no additional drilling of the door is required, thus ensuring existing doors are not damaged.



TECHNICAL CHARACTERISTICS:

- Covers door thicknesses: From 32mm up to 120mm.
- Dimensions: 298mm x 54mm x 24mm. (Outside)
285mm x 57mm x 20mm. (Inside)
- Clutch mechanism escutcheon; when unlocked handle moves freely.
- Reversible handle left or right escutcheon.
- Handle rotation: 45°.
- Distance from the handle to the cylinder: 47mm to 110mm.
- Compatible with DIN mortise locks.
- Square spindles available: 7mm, 8mm, 8mm split, 9mm and 9mm split.

TECHNOLOGY PLATFORMS:



ID TECHNOLOGIES:

- MIFARE® (DESFire EV1, Plus, Ultralight C, Classic - ISO/IEC 14443).
- Bluetooth SMART (BLE).
- HID iCLASS® Seos™.
- NFC.

FEATURES:

- Simple installation is possible on any type of door, including those with narrow frames.
- Body and escutcheon made of steel.
- Available with mechanical cylinder cut outs for key override or access lock outs (override European profile cylinder) with audit trail facility available.
- Electronic privacy option.
- The lock can always be opened from the inside (single action panic feature works in conjunction with the relevant mortise lock).
- Rose and Short plate door cut preparation options available.

READER COLOUR:



FINISHES:

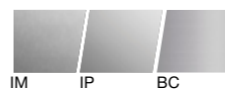

TECHNICAL DRAWING:

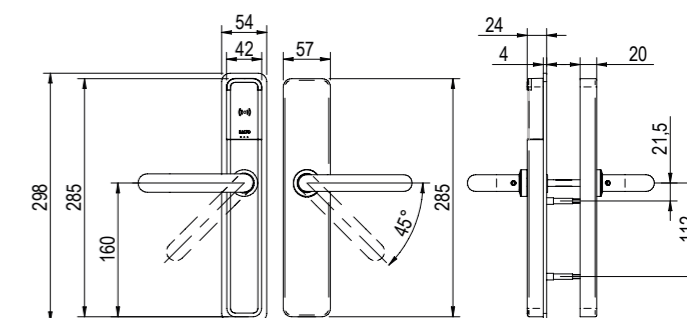

CERTIFICATIONS:

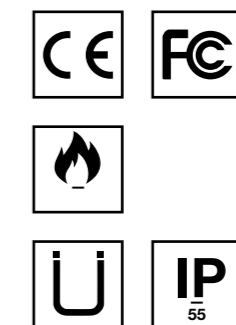

(1) External escutcheon.

XS4 ORIGINAL - EU

EX40 | XS4 ORIGINAL NARROW BODY VERSION

The SALTO XS4 Original narrow body version is specially designed to fit most Euro profile doors, even narrow profile framed doors. This version also works with the majority of European mortise locks and cylinders.



TECHNICAL CHARACTERISTICS:

- Covers door thicknesses: From 32mm up to 120mm.
- Dimensions: 282mm x 40mm x 20mm.
- Reversible handle left or right escutcheon.
- Clutch mechanism escutcheon; when unlocked handle moves freely.
- Handle rotation: 33°.
- Distance from the handle to the cylinder: 47mm to 110mm.
- Compatible with DIN and European mortise locks, mortise locks with Swiss profile cylinder, Australian standard mortise locks and narrow style mortise lock.
- Compatible with European profile and Swiss profile cylinders.
- Square spindles available: 7mm, 7.6mm split (Australia), 8mm, 8mm split (Euro & ANSI), 9mm and 9mm split.

TECHNOLOGY PLATFORMS:



ID TECHNOLOGIES:

- MIFARE® (DESFire EV1, Plus, Ultralight C, Classic - ISO/IEC 14443).
- Bluetooth SMART (BLE).
- NFC.
- Inside Picopass.
- LEGIC Prime and LEGIC Advant.
- HID iCLASS® Seos™.
- i-Button.

FEATURES:

- Simple installation is possible on any type of door, including those with narrow frames.
- Body and escutcheon made of steel.
- Available with mechanical cylinder cut outs for key override or access lock outs (override European and Cam profile cylinder) with audit trail facility available.
- Mechanical or electronic privacy option.
- AMOK option for offline lockdown.
- The lock can always be opened from the inside (single action panic feature works in conjunction with the relevant mortise lock).
- Complementary escutcheons without reader available to maintain the aesthetics of doors that do not need to be controlled.

READER COLOUR:



FINISHES:

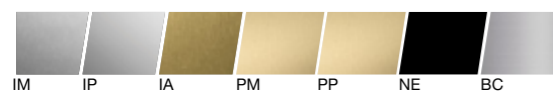

TECHNICAL DRAWING:

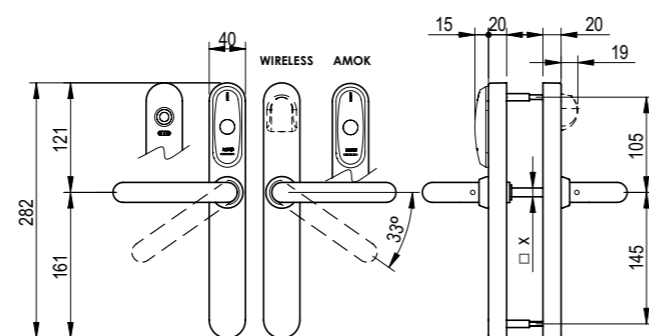

CERTIFICATIONS:

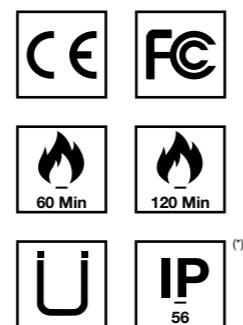

⁽¹⁾ External escutcheon.

XS4 ORIGINAL WIDE - EU

XS4 Ex60 | XS4 ORIGINAL EU WIDE BODY VERSION

The SALTO XS4 Original wide version is specially designed to fit most Euro profile doors and work with the majority of European mortise locks and cylinders. It is specially designed for use on busy, high traffic doors that need additional strength.



TECHNICAL CHARACTERISTICS:

- Covers door thicknesses: From 32mm up to 120mm.
- Dimensions: 290mm x 67mm x 20mm.
- Reversible handle left or right escutcheon.
- Clutch mechanism escutcheon; when unlocked handle moves freely.
- Handle rotation: 52°.
- Distance from the handle to the cylinder: 47mm to 110mm.
- Compatible with DIN and European mortise locks, mortise locks with Swiss profile cylinder, Australian standard mortise locks and narrow style mortise lock.
- Compatible with European profile and Swiss profile cylinders.
- Door thickness: Square spindles available: 7mm, 7.6mm split (Australia), 8mm, 8mm split (Euro & ANSI), 9mm and 9mm split.

TECHNOLOGY PLATFORMS:

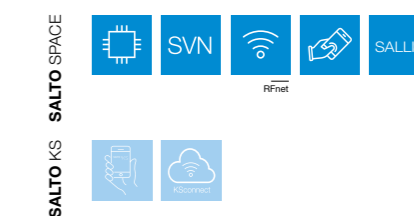

ID TECHNOLOGIES:

- MIFARE® (DESFire EV1, Plus, Ultralight C, Classic - ISO/IEC 14443).
- Bluetooth SMART (BLE).
- NFC.
- Inside Picopass.
- LEGIC Prime and LEGIC Advant.
- HID iCLASS® Seos™.
- i-Button.

FEATURES:

- Simple installation is possible on any type of door.
- Body and escutcheon made of steel.
- Available with mechanical cylinder cut outs for key override or access lock outs (override European and Cam profile cylinder) with audit trail facility available.
- Mechanical or electronic privacy option.
- AMOK option for offline lockdown.
- The lock can always be opened from the inside (single action panic feature works in conjunction with the relevant mortise lock).
- Complementary escutcheons without reader available to maintain the aesthetics of doors that do not need to be controlled.

READER COLOUR:



FINISHES:

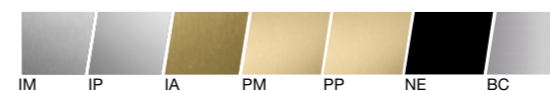

TECHNICAL DRAWING:

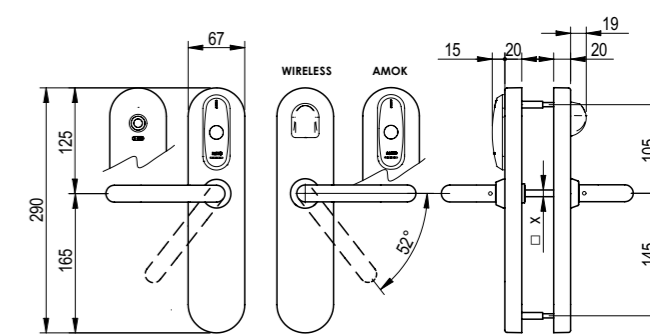

CERTIFICATIONS:

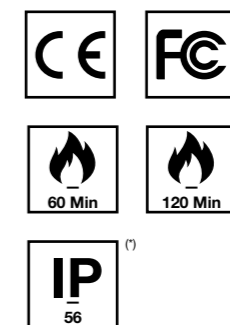

⁽¹⁾ External escutcheon.

XS4 ORIGINAL KEYPAD - EU

Ex60 | XS4 ORIGINAL EU KEYPAD

The SALTO XS4 Original electronic lock with keypad increases security and control, as it offers the choice of three forms of authentication to grant access.



FEATURES:

- Simple installation is possible on any type of door, including those with narrow frames.
- Body and escutcheon made of steel.
- Three forms of authentication configurations available to grant access:
 - Credential only.
 - Credential plus PIN.
 - Door code.
- Available with mechanical cylinder cut outs for key override or access lock outs (override European and Cam profile cylinder) with audit trail facility available.
- Mechanical or electronic privacy option.
- The lock can always be opened from the inside (single action panic feature works in conjunction with the relevant mortise lock).

READER COLOUR:



FINISHES:

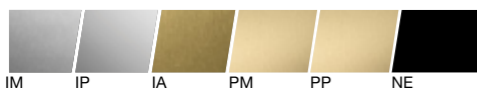

TECHNICAL CHARACTERISTICS:

- Covers door thicknesses: From 32mm up to 120mm.
- Dimensions: 290mm x 67mm x 20mm.
- Reversible handle left or right escutcheon.
- Clutch mechanism escutcheon; when unlocked handle moves freely.
- Handle rotation: 52°.
- Distance from the handle to the cylinder: 47mm to 110mm.
- Compatible with DIN and European mortise locks, mortise locks with Swiss profile cylinder, Australian standard mortise locks and narrow style mortise lock.
- Compatible with European profile and Swiss profile cylinders.
- Door thickness: Square spindles available: 7mm, 7.6mm split (Australia), 8mm, 8mm split (Euro & ANSI), 9mm and 9mm split.

TECHNOLOGY PLATFORMS:



ID TECHNOLOGIES:

- MIFARE® (DESFire EV1, Plus, Ultralight C, Classic - ISO/IEC 14443).
- Bluetooth SMART (BLE).
- NFC.
- HID iCLASS® (This technology is currently not available for SALLIS).

TECHNICAL DRAWING:

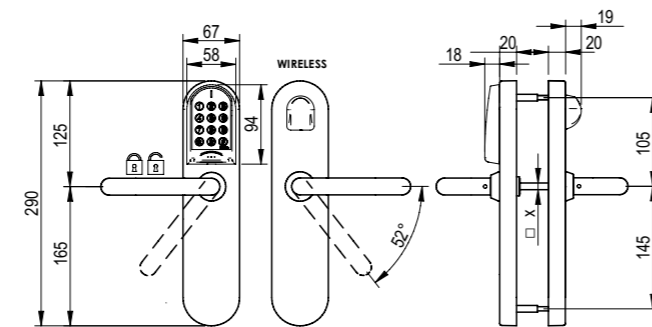

CERTIFICATIONS:



XS4 ORIGINAL - SKG**

XS4 Ex4K | XS4 ORIGINAL EU SKG** VERSION

The SALTO XS4 Original SKG is designed to suit the needs of those doors that necessitate special reinforcement or require SKG certification against burglary.



FEATURES:

- Security escutcheon for protection against attack and unauthorized entry; SKG certification.
- Simple installation is possible on any type of door, including those with narrow frames.
- Body and escutcheon made of steel.
- Available with mechanical cylinder cut outs for key override or access lock outs (override European profile SKG** emergency cylinder).
- AMOK option for offline lockdown.
- The lock can always be opened from the inside (single action panic feature works in conjunction with the SKG** mortise lock).

READER COLOUR:



FINISHES:

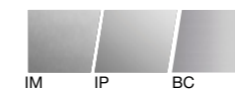

TECHNICAL CHARACTERISTICS:

- Covers door thicknesses: From 32mm up to 120mm.
- Dimensions: 290mm x 40mm x 20mm.
- Clutch mechanism escutcheon; when unlocked handle moves freely.
- Reversible handle left or right escutcheon.
- Handle rotation: 33°.
- Distance from the handle to the cylinder: 47mm to 110mm.
- Compatible with DIN and European SKG** mortise locks.
- Compatible with European profile SKG** emergency cylinders.
- Door thickness: Square spindles available: 8mm, 8mm split, 9mm and 9mm split.

TECHNOLOGY PLATFORMS:

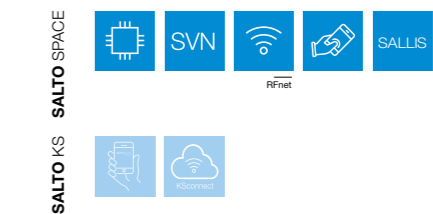

ID TECHNOLOGIES:

- MIFARE® (DESFire EV1, Plus, Ultralight C, Classic - ISO/IEC 14443).
- Bluetooth SMART (BLE).
- NFC.
- Inside Picopass.
- LEGIC Prime and LEGIC Advant.
- HID iCLASS® Seos™.
- i-Button.

TECHNICAL DRAWING:

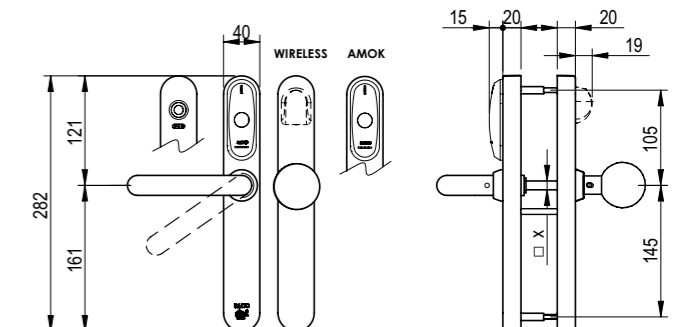

CERTIFICATIONS:

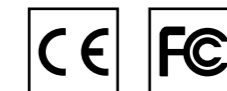

⁽¹⁾ External escutcheon.

XS4 ORIGINAL - DIN

XS4 Ex50 | XS4 ORIGINAL DIN VERSION

The SALTO XS4 Original DIN version escutcheon is specially designed to meet the requirements of DIN18250 and 18251 standard doors prepared for DIN 18250 standard mortise locks. The XS4 Original DIN escutcheon maintains the fire rating of the door as no additional drilling of the door is required.



TECHNICAL CHARACTERISTICS:

- Covers door thicknesses: From 32mm up to 120mm.
- Dimensions: 269mm x 55mm x 22,5mm. (Outside)
290mm x 67mm x 20mm. (Inside)
- Clutch mechanism escutcheon; when unlocked handle moves freely.
- Reversible handle left or right escutcheon.
- Handle rotation: 30°.
- Distance from the handle to the cylinder: 47mm to 110mm.
- Compatible with DIN mortise locks.
- Square spindles available: 7mm, 8mm, 8mm split, 9mm and 9mm split.

TECHNOLOGY PLATFORMS:

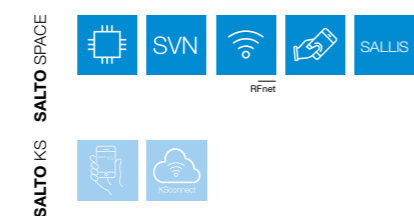

ID TECHNOLOGIES:

- MIFARE® (DESFire EV1, Plus, Ultralight C, Classic - ISO/IEC 14443).
- Bluetooth SMART (BLE).
- NFC.
- Inside Picopass.
- LEGIC Prime and LEGIC Advant.
- HID iCLASS® Seos™
- i-Button.

TECHNICAL DRAWING:

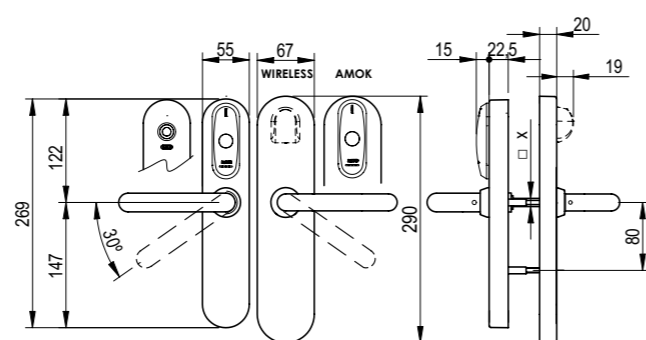

FEATURES:

- The fire rating of the door is maintained as no additional drilling of the door is required.
- Body and escutcheon made of steel.
- Available with mechanical cylinder cut outs for key override or access lock outs (override European profile cylinder) with audit trail facility available.
- Electronic privacy option.
- AMOK option for offline lockdown.
- The lock can always be opened from the inside (single action panic feature works in conjunction with the relevant mortise lock).

READER COLOUR:



FINISHES:

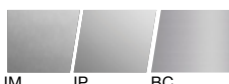

IM IP BC

CERTIFICATIONS:

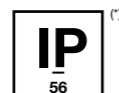

(1) External escutcheon.

XS4 ORIGINAL DOUBLE READER - EU

ExCD | XS4 ORIGINAL EU DOUBLE READER

The XS4 Original Double Reader electronic escutcheon controls both the entry and exit access of a door. Its audit trail facility can identify entry and exit actions, and can be fitted to almost any type of Euro profile door. It can also operate with a wide range of locks including Swiss cylinders.



Inside

Outside

TECHNICAL CHARACTERISTICS:

- Covers door thicknesses: From 32mm up to 120mm.
- Dimensions: 280mm x 37mm x 9,5mm. (Outside)
366mm x 42,5mm x 22mm. (Inside)
- Double reader escutcheon for control of both entry and exit, also with different authorizations.
- Handle rotation: 33°.
- Distance from the handle to the cylinder: 47mm to 110mm.
- Compatible with DIN, European and Scandinavian mortise locks, standard mortise locks and narrow style mortise locks.
- Compatible with European profile and Swiss profile cylinders.
- Door thickness: Square spindles available: 8mm and 9mm.
- Optional torx 20 tamper resistant proof screw for quick and secure installation from inside.

TECHNOLOGY PLATFORMS:

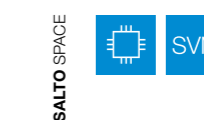

ID TECHNOLOGIES:

- MIFARE® (DESFire EV1, Plus, Ultralight C, Classic - ISO/IEC 14443).
- NFC.
- Inside Picopass.
- LEGIC Prime.
- HID iCLASS®.
- i-Button.

TECHNICAL DRAWING:

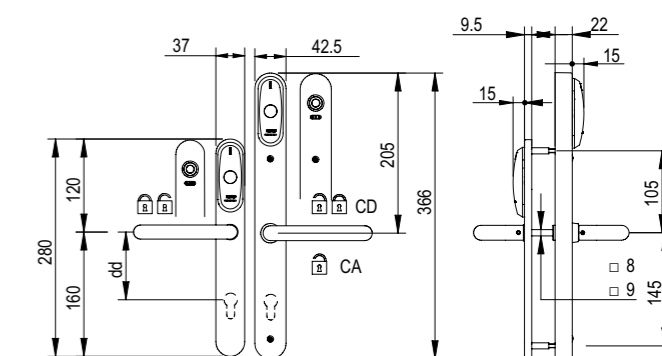

FEATURES:

- Simple installation is possible on any type of door, including those with narrow frames.
- Body and escutcheon made of steel.
- Available with mechanical cylinder cut outs for key override or access lock outs (override European and Swiss profile cylinder).

READER COLOUR:



FINISHES:



IM IP NE

CERTIFICATIONS:



(1) External escutcheon.

XS4 ORIGINAL SECURITY - EU

XS4 Ex20 | XS4 ORIGINAL EU SECURITY MODEL

The SALTO XS4 security model is an ideal choice for use on doors where a higher level of security protection is required, such as exterior doors, main entrances and high security openings. The tough, vandal-resistant construction protects this range against attack and unauthorised entry without losing flexibility or control.



FEATURES:

- Simple installation is possible on any type of door, including those with narrow frames.
- Body and escutcheon made of steel.
- Electronic privacy option.
- Complementary escutcheons without reader available to maintain the aesthetics of doors that do not need to be controlled.

READER COLOUR:



FINISHES:

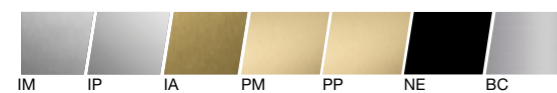

TECHNICAL CHARACTERISTICS:

- Covers door thicknesses: From 32mm up to 120mm.
- Dimensions: 280mm x 37mm x 9,5mm (Outside) and 280mm x 42, 5mm x 22mm (Inside).
- Handle rotation: 30°.
- Distance from the handle to the cylinder: 47mm to 110mm.
- Compatible with DIN and European mortise locks, standard mortise locks and narrow style mortise locks.
- Compatible with European profile and Swiss profile cylinders.
- Door thickness: Square spindles available: 8mm and 9mm.
- Optional torx 20 tamper resistant proof screw for quick and secure installation from inside.

TECHNOLOGY PLATFORMS:

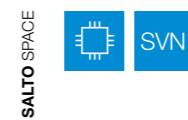

ID TECHNOLOGIES:

- MIFARE® (DESFire EV1, Plus, Ultralight C, Classic - ISO/IEC 14443).
- NFC.
- Inside Picopass.
- LEGIC Prime.
- HID iCLASS®.
- i-Button.

TECHNICAL DRAWING:

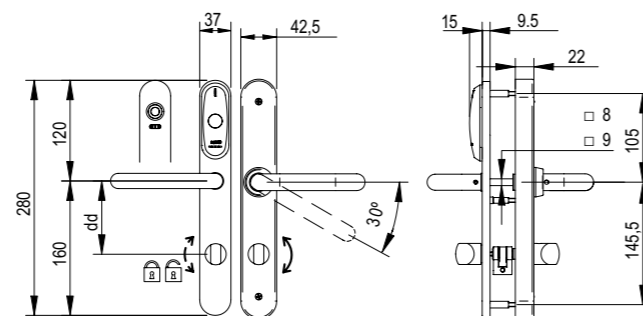

CERTIFICATIONS:

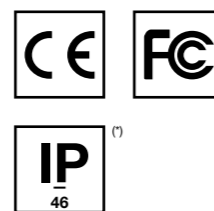

⁽¹⁾ External escutcheon.

XS4 ORIGINAL - NORDIC

XS4 Sx40 | XS4 NORDIC ORIGINAL

The XS4 Original Nordic narrow body version is specially designed to fit most Scandinavian profile and narrow profile framed doors and to work with standard Scandinavian mortise locks and cylinders.



FEATURES:

- Simple installation is possible on any type of door, including those with narrow frames.
- Body and escutcheon made of steel.
- Available with mechanical cylinder cut outs for key override or access lock outs (override Scandinavian cylinder).
- Mechanical or electronic privacy option.
- AMOK option for offline lockdown.
- The lock can always be opened from the inside (single action panic feature works in conjunction with the SALTO LS5N15 series mortise lock).
- Complementary escutcheons without reader available to maintain the aesthetics of doors that do not need to be controlled.

READER COLOUR:



FINISHES:

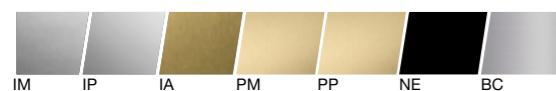

TECHNICAL CHARACTERISTICS:

- Covers door thicknesses: From 32mm up to 120mm.
- Dimensions: 282mm x 40mm x 20mm.
- Clutch mechanism escutcheon; when unlocked handle moves freely.
- Reversible handle left or right escutcheon.
- Handle rotation: 33°.
- Distance from the handle to the cylinder: 105mm.
- Compatible with Scandinavian standard mortise locks.
- Initial max. 4° pre-turn. SALTO recommends the use of a mortise lock with a maximum 4° pre-turn.
- Compatible with Scandinavian oval profile cylinders.
- Square spindles available: 8mm and 8mm split.

TECHNOLOGY PLATFORMS:



ID TECHNOLOGIES:

- MIFARE® (DESFire EV1, Plus, Ultralight C, Classic - ISO/IEC 14443).
- Bluetooth SMART (BLE).
- NFC.
- Inside Picopass.
- LEGIC Prime and LEGIC Advant.
- HID iCLASS® Seos™.
- i-Button.

TECHNICAL DRAWING:

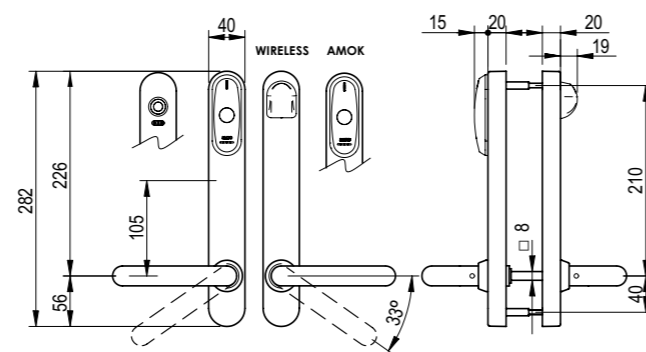

CERTIFICATIONS:

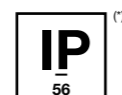

⁽¹⁾ External escutcheon.

XS4 ORIGINAL WIDE - NORDIC

XS4 Sx60 | XS4 NORDIC ORIGINAL WIDE BODY VERSION

The XS4 Original Nordic wide body version is specially designed for use on busy, high traffic doors that need additional strength or to cover old hardware holes and to work with standard Scandinavian mortise locks and cylinders.



FEATURES:

- Simple installation is possible on any type of door.
- Body and escutcheon made of steel.
- Available with mechanical cylinder cut outs for key override or access lock outs (override Scandinavian oval cylinders).
- Mechanical or electronic privacy option.
- AMOK option for offline lockdown.
- The lock can always be opened from the inside (single action panic feature works in conjunction with the SALTO LS5N15 series mortise lock).
- Complementary escutcheons without reader available to maintain the aesthetics of doors that do not need to be controlled.

READER COLOUR:



FINISHES:

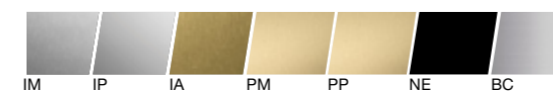

TECHNICAL CHARACTERISTICS:

- Covers door thicknesses: From 32mm up to 120mm.
- Dimensions: 290mm x 67mm x 20mm.
- Clutch mechanism escutcheon; when unlocked handle moves freely.
- Reversible handle left or right escutcheon.
- Handle rotation: 52°.
- Distance from the handle to the cylinder: 105mm.
- Compatible with Scandinavian standard mortise locks.
- Compatible with Scandinavian oval profile cylinders.
- Square spindles available: 8mm and 8mm split.

TECHNOLOGY PLATFORMS:

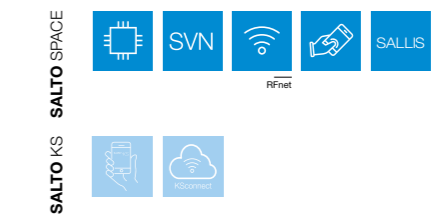

ID TECHNOLOGIES:

- MIFARE® (DESFire EV1, Plus, Ultralight C, Classic - ISO/IEC 14443).
- Bluetooth SMART (BLE).
- NFC.
- Inside Picopass.
- LEGIC Prime and LEGIC Advant.
- HID iCLASS® Seos™.
- i-Button.

TECHNICAL DRAWING:

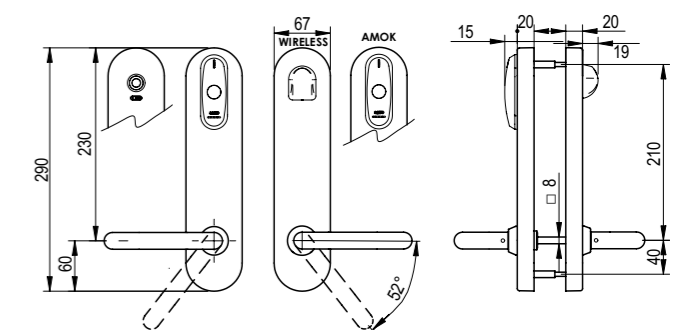

CERTIFICATIONS:

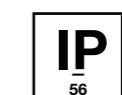

⁽¹⁾ External escutcheon.

XS4 ORIGINAL KEYPAD - NORDIC

XS4 Sx60K | XS4 NORDIC ORIGINAL WITH KEY PAD

The SALTO XS4 Original Nordic electronic lock with keypad increases security and control, as it offers the choice of three forms of authentication to grant access.



FEATURES:

- Simple installation is possible on any type of door, including those with narrow frames.
- Body and escutcheon made of steel.
- Three forms of authentication configurations available to grant access:
 - Credential only.
 - Credential plus PIN.
 - Door code.
- Available with mechanical cylinder cut outs for key override or access lock outs (override Scandinavian oval cylinders).
- Mechanical or electronic privacy option.
- The lock can always be opened from the inside (single action panic feature works in conjunction with the SALTO LS5N15 series mortise lock).

READER COLOUR:



FINISHES:

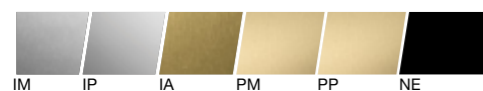

TECHNICAL CHARACTERISTICS:

- Covers door thicknesses: From 32mm up to 120mm.
- Dimensions: 290mm x 67mm x 20mm.
- Clutch mechanism escutcheon; when unlocked handle moves freely.
- Reversible handle left or right escutcheon.
- Handle rotation: 52°.
- Distance from the handle to the cylinder: 105mm.
- Compatible with Scandinavian standard mortise locks.
- Compatible with Scandinavian oval profile cylinders.
- Square spindles available: 8mm and 8mm split.

TECHNOLOGY PLATFORMS:



ID TECHNOLOGIES:

- MIFARE® (DESFire EV1, Plus, Ultralight C, Classic - ISO/IEC 14443).
- Bluetooth SMART (BLE).
- NFC.
- HID iCLASS® (This technology is currently not available for SALLIS).

TECHNICAL DRAWING:

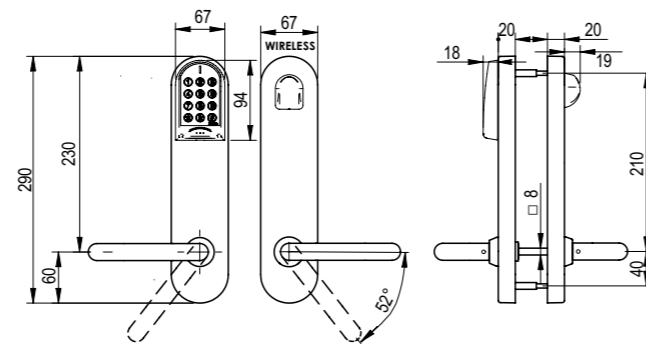

CERTIFICATIONS:



XS4 ORIGINAL SECURITY - NORDIC

XS4 Sx20 | XS4 NORDIC ORIGINAL SECURITY MODEL

The SALTO XS4 Original Nordic security model is an ideal choice for use on doors where a higher level of security protection is required, such as exterior doors, main entrances and high security openings. The tough, vandal-resistant construction protects this range against attack and unauthorised entry without losing flexibility or control.



FEATURES:

- Simple installation is possible on any type of door, including those with narrow frames.
- Body and escutcheon made of steel.
- Electronic privacy option.
- The lock can always be opened from the inside (single action panic feature works in conjunction with the SALTO LS5N15 series mortise lock).
- Complementary escutcheons without reader available to maintain the aesthetics of doors that do not need to be controlled.

READER COLOUR:



FINISHES:

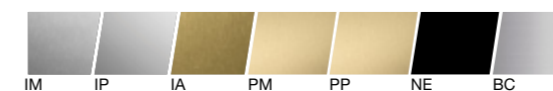

TECHNICAL CHARACTERISTICS:

- Covers door thicknesses: From 32mm up to 120mm.
- Dimensions: 280mm x 37mm x 9,5mm.
- Handle rotation: 30°.
- Distance from the handle to the cylinder: 105mm.
- Compatible with Scandinavian standard mortise locks.
- Initial max. 4° pre-turn. SALTO recommends the use of a mortise lock with a maximum 4° pre-turn.
- Compatible with Scandinavian oval profile cylinders.
- Square spindles available: 8mm and 8mm split.
- Optional torx 20 tamper resistant proof screw for quick and secure installation from inside.

TECHNOLOGY PLATFORMS:

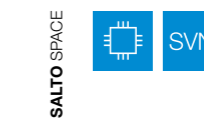

ID TECHNOLOGIES:

- MIFARE® (DESFire EV1, Plus, Ultralight C, Classic - ISO/IEC 14443).
- NFC.
- Inside Picopass.
- LEGIC Prime.
- HID iCLASS®.
- i-Button.

TECHNICAL DRAWING:

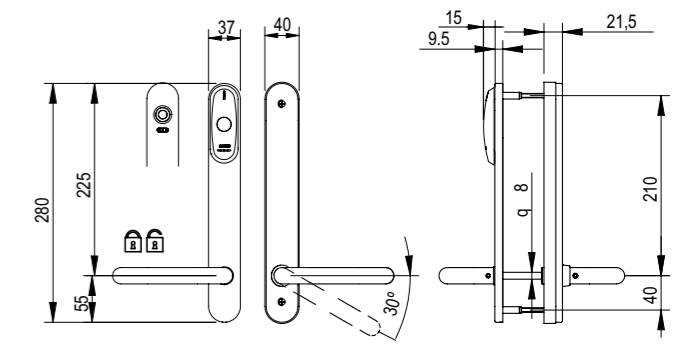

CERTIFICATIONS:



(*) External escutcheon.

XS4 ORIGINAL - ANSI

XS4 Ax60 | [XS4 ORIGINAL](#)

The XS4 Original wide body version for ANSI mortise locks is specially designed to be compatible with most ANSI mortise locks and tubular latches. It is specially designed for use on busy, high traffic doors that need additional strength.



TECHNICAL CHARACTERISTICS:

- Covers door thicknesses: From 32 (1-3/8") up to 120 mm (4-3/4").
- Dimensions: 290mm (11-27/64") x 67mm (2-5/8") x 20mm (25/32").
- Clutch mechanism escutcheon; when unlocked handle moves freely.
- Reversible handle left or right escutcheon.
- Handle rotation: 52°.
- Distance from the handle to the cylinder: 61mm (2-13/32"), 62mm (2-7/16") and 63mm (2-1/2").
- Compatible with ANSI standard cylindrical and mortise locks.
- Initial max. 4° pre-turn. SALTO recommends the use of a mortise lock with a maximum 4° pre-turn.
- Compatible with ANSI mortise cylinders.
- Square spindles available: 8mm (5/16"), 7mm diamond (7/32"), 8mm split (5/16"), 7mm diamond split (7/32") and 7,6mm (19/64").

TECHNOLOGY PLATFORMS:

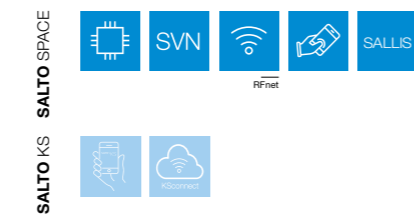

ID TECHNOLOGIES:

- MIFARE® (DESFire EV1, Plus, Ultralight C, Classic - ISO/IEC 14443).
- Bluetooth SMART (BLE).
- NFC.
- Inside Picopass.
- LEGIC Prime and LEGIC Advant.
- HID iCLASS® Seos™.
- i-Button.

FEATURES:

- Simple installation is possible on any type of door, including those with narrow frames.
- Body and escutcheon made of steel.
- Available with mechanical cylinder cut outs for key override or access lock outs (override mortise cylinders).
- Mechanical or electronic privacy option.
- AMOK option for offline lockdown.
- The lock can always be opened from the inside (single action panic feature works in conjunction with the SALTO LA1T15 series mortise lock).
- Complementary escutcheons without reader available to maintain the aesthetics of doors that do not need to be controlled.

READER COLOUR:



FINISHES:

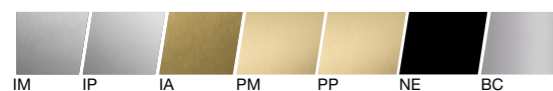

TECHNICAL DRAWING:

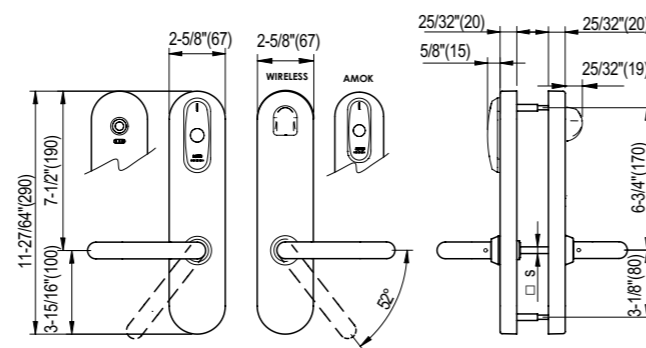

CERTIFICATIONS:

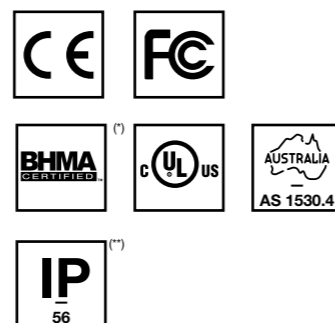

(1) With SALTO LA1T lock case
(2) External escutcheon.

XS4 ORIGINAL KEYPAD - ANSI

XS4 Ax60K | [XS4 ORIGINAL WITH KEYPAD](#)

The SALTO XS4 ANSI electronic lock with keypad, designed to be compatible with most ANSI mortise locks and tubular latches, increases security and control as it offers the choice of three forms of authentication to grant access.



TECHNICAL CHARACTERISTICS:

- Covers door thicknesses: From 32 (1-3/8") up to 120 mm (4-3/4").
- Dimensions: 290mm (11-27/64") x 67mm (2-5/8") x 20mm (25/32").
- Clutch mechanism escutcheon; when unlocked handle moves freely.
- Reversible handle left or right escutcheon.
- Handle rotation: 52°.
- Distance from the handle to the cylinder: 61mm (2-13/32"), 62mm (2-7/16") and 63mm (2-1/2").
- Compatible with ANSI standard cylindrical and mortise locks.
- Initial max. 4° pre-turn. SALTO recommends the use of a mortise lock with a maximum 4° pre-turn.
- Compatible with ANSI mortise cylinders.
- Square spindles available: 8mm (5/16"), 7mm diamond (7/32"), 8mm split (5/16"), 7mm diamond split (7/32") and 7,6mm (19/64").

TECHNOLOGY PLATFORMS:



ID TECHNOLOGIES:

- MIFARE® (DESFire EV1, Plus, Ultralight C, Classic - ISO/IEC 14443).
- Bluetooth SMART (BLE).
- NFC.
- HID iCLASS® (This technology is currently not available for SALLIS).

FEATURES:

- Simple installation is possible on any type of door, including those with narrow frames.
- Body and escutcheon made of steel.
- Three forms of authentication configurations available to grant access:
 - Credential only.
 - Credential plus PIN.
 - Door code.
- Available with mechanical cylinder cut outs for key override or access lock outs (override mortise cylinders).
- Mechanical or electronic privacy option.
- The lock can always be opened from the inside (single action panic feature works in conjunction with the SALTO LA1T15 series mortise lock).

READER COLOUR:



FINISHES:

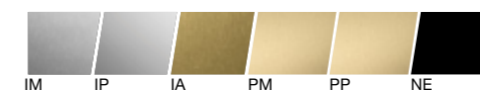

TECHNICAL DRAWING:

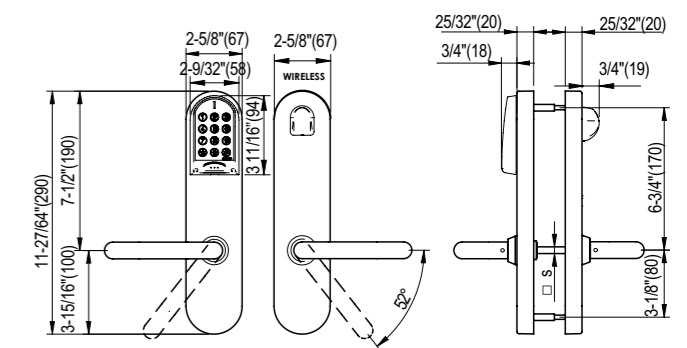

CERTIFICATIONS:



XS4 GLASS DOOR - DIN

XS4 ExGD | GLASS DOOR LOCK DIN18101

The XS4 Original DIN glass door lock has been specially designed for use with DIN 18101 standard glass doors. Its steel body is stylish and modern and its unique 'sandwich body' construction makes it easy to install, without having to replace the door. A wireless version of the XS4 DIN glass door lock is also available for real-time access control requirements.



TECHNICAL CHARACTERISTICS:

- Covers door thicknesses: From 8mm up to 14mm.
- Dimensions: 296mm x 98,5mm x 22,5mm.
- Clutch mechanism escutcheon; when unlocked handle moves freely.
- Handle rotation: 52°.
- Distance from the handle to the cylinder: 72mm.
- DIN 18101 standard prepared for DIN 18101 standard glass doors.
- Automatic lock, the auxiliary latch (anti-card) projects and deadlocks the deadbolt.
- Compatible with European profile cylinders.
- Handle compatibility: 16mm Ø, 18mm Ø.
- Handed mortise lock.

TECHNOLOGY PLATFORMS:

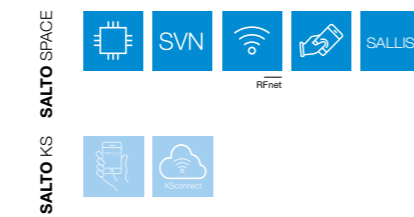

ID TECHNOLOGIES:

- MIFARE® (DESFire EV1, Plus, Ultralight C, Classic - ISO/IEC 14443).
- Bluetooth SMART (BLE).
- NFC.
- Inside Picopass.
- LEGIC Prime and LEGIC Advant.
- HID iCLASS® Seos™.
- i-Button.

TECHNICAL DRAWING:

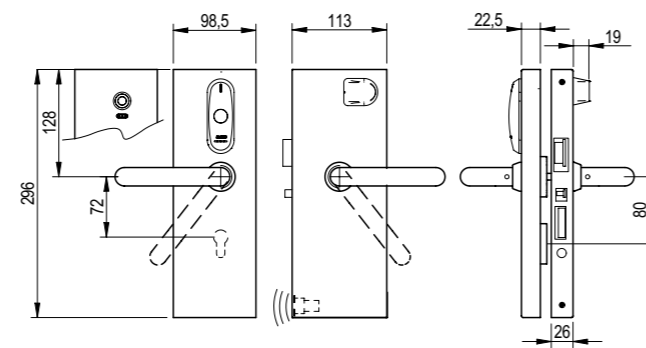

CERTIFICATIONS:



FEATURES:

- Sandwich body design for easy installation.
- Body and escutcheon made of steel.
- Available with mechanical cylinder cut outs for key override or access lock outs (override European profile cylinder) with audit trail facility available.
- The lock can always be opened from the inside (single action panic feature works in conjunction with the SALTO automatic mortise lock).
- Door status detector inside to monitor intrusions or door left open status (wireless escutcheons only).
- Strike plates for glass frames and double doors available to meet the installation needs.
- Complementary escutcheons without reader available to maintain the aesthetics of doors that do not need to be controlled.

READER COLOUR:



FINISHES:



IM

XS4 GLASS DOOR

XS4 ExGM | GLASS DOOR LOCK

The XS4 glass door lock's exclusive design makes it compatible with a wide range of commonly used glass door designs, including those already fitted with a built-in lock. Its unique 'sandwich body' design also makes for easy installation, without having to replace the door.



TECHNICAL CHARACTERISTICS:

- Covers door thicknesses: 8mm, 10 mm and 12mm.
- Dimensions: 135mm x 148,5mm x 17mm.
- Handle rotation: 33°.
- Handed mortise lock.

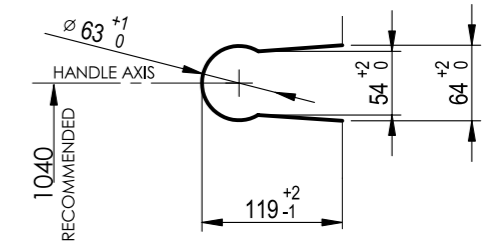

TECHNOLOGY PLATFORMS:

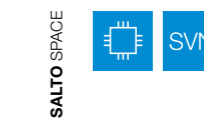

ID TECHNOLOGIES:

- MIFARE® (DESFire EV1, Plus, Ultralight C, Classic - ISO/IEC 14443).
- NFC.
- Inside Picopass.
- LEGIC Prime.
- HID iCLASS®.
- i-Button.

TECHNICAL DRAWING:

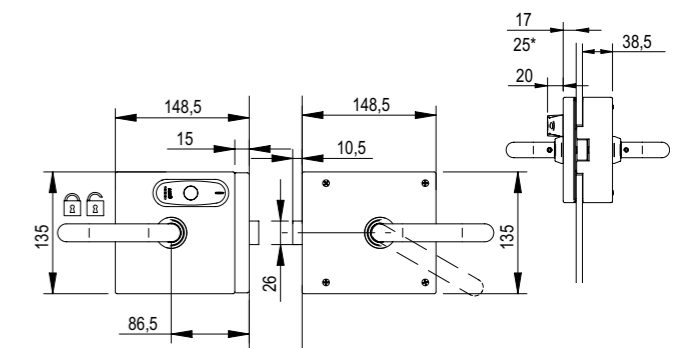

CERTIFICATIONS:



FEATURES:

- Simple installation is possible on any type of glass door.
- Body and escutcheon made of steel.
- The lock can always be opened from the inside (single action panic feature works in conjunction with the SALTO mortise lock).
- Strike plates for glass frames and double doors available to meet the installation needs.

READER COLOUR:



FINISHES:



IM

REFERENCE GUIDE INFORMATION

XS4 BY SALTO | ELECTRONIC ESCUTCHEONS

Wire-free, easy to install and simple to use battery-operated electronic locking systems that can be fitted to almost any type of existing door and lock standards that are already in place anywhere for key control.

E	9	4	5	0	U	00	IM	3	8	R	W
—	—	—	—	—	—	—	—	—	—	—	—
PRODUCT TYPE	ID TECHNOLOGY	ESCUTCHEON WIDTH	ESCUTCHEON MODEL	FUNCTION	HANDLE	HANDLE TO CYLINDER DISTANCE	FINISHES	DOOR THICKNESS	SQUARE SPINDLE	HANDING	WIRELESS / AMOK / KEYPAD / SALTO KS / SALLIS
—	—	—	—	—	—	—	—	—	—	—	—
1	2	3	4	5	6	7	8	9	10	11	12

1 | PRODUCT TYPE

- E** European escutcheons compatible with European mortise locks.
- A** ANSI escutcheons compatible with ANSI mortise locks.
- S** Scandinavian escutcheons compatible with Scandinavian mortise locks.

3 | ESCUTCHEON WIDTH

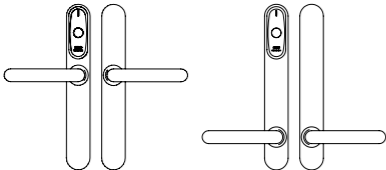
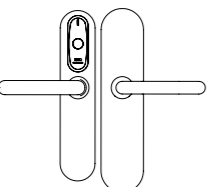
- 4** 40mm narrow body escutcheons. 
- 5** 55mm DIN model escutcheons. 

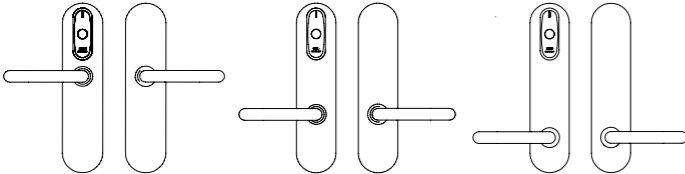
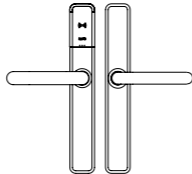
- 6** 67mm wide model escutcheons. 
- 7** XS4 One narrow body escutcheons. 

2 | ID TECHNOLOGY

i-Button

- A** i-Button Smile.
- 1** i-Button ROM.
- 2** i-Button RW.

RFID

- 7** Contactless Inside Picopass.
- 8** Contactless LEGIC Advant & Prime.
- 9** Contactless MIFARE® (DESFire EV1, Plus, Ultralight C, Classic - ISO/IEC 14443).
- H** Contactless HID iCLASS® Seos™.
- B** Contactless BLE & MIFARE DESFire.

4 | ESCUTCHEON MODEL

- 5** Clutch.
- 6** Clutch + override.
- P** Clutch + Euro profile cylinder override.
- E** ANSI escutcheons compatible with ANSI mortise locks.
- K** SKG model (only for European narrow body escutcheons).

5 | FUNCTION

- 0** 2 Handles, any type.
- 1** 2 Handles, any type, inside thumbturn, with connector for mortise lock with micro-switch.
- 2** 2 Handles, any type, Inside/Outside cylinder cut out.
- 3** 2 Handles, any type, Inside cylinder cut out.
- 4** 2 Handles, any type, Outside cylinder cut out.
- 6** 2 Handles, any type, Electronic “do not disturb” system.
- 7** 2 Handles, any type, Outside cylinder cut out, Electronic “do not disturb” system.

6 | HANDLE

XS4 offers a wide choice of functional and stylishly designed handles suitable for use on any type of door. Many of the lever handles have been designed to meet the latest DDA (Disability Discrimination Act) requirements, ensuring they are simple and easy to operate.

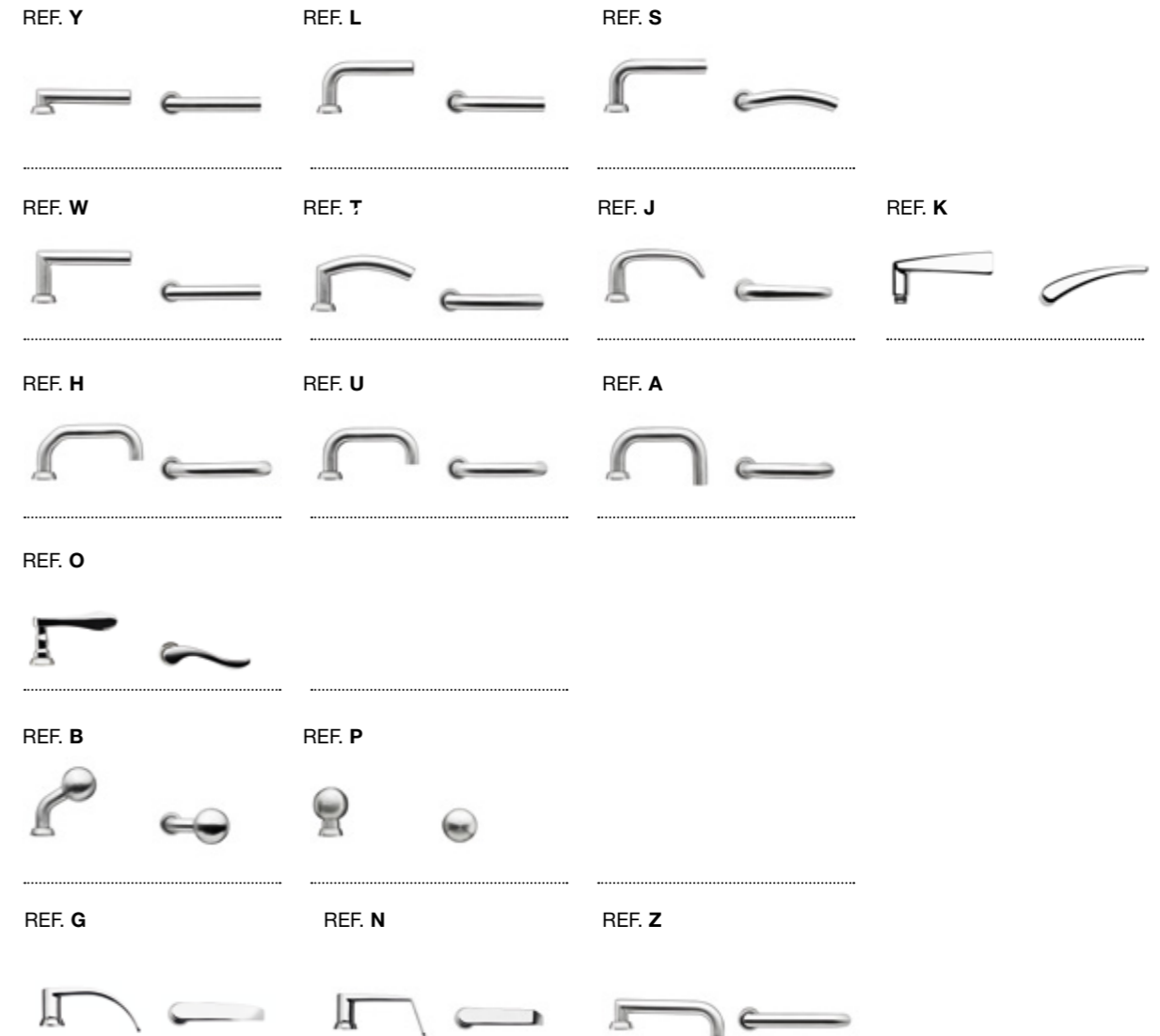

7 | HANDLE TO CYLINDER DISTANCE

00	Without distance.	3R	73,5mm Swiss profile cylinder.
47	47mm Euro profile cylinder.	4R	74mm Swiss profile cylinder.
48	48mm Euro profile cylinder.	7R	78mm Swiss profile cylinder.
49	49mm Euro profile cylinder.	85	85mm Euro profile cylinder.
55	55mm Euro profile cylinder.	88	88mm Euro profile cylinder.
62	62mm Euro profile cylinder.	90	90mm Euro profile cylinder.
70	70mm Euro profile cylinder.	92	92mm Euro profile cylinder.
72	72mm Euro profile cylinder.	9R	93mm Swiss profile cylinder.
7F	72mm for fire doors.	10	100mm Euro profile cylinder.
78	78mm Euro profile cylinder.	11	110mm Euro profile cylinder.

8 | FINISHES

Various finish options are available to allow for contemporary or classic styling to match any taste or design in décor, and to help in DDA impaired vision requirements.

Stainless steel finishes



Satin
Stainless Steel
(IM)

Brass finishes



Polished
Stainless Steel
(IP)



Antique
Brass
(IA)



Satin
Brass PVD
(PM)



Polished
Brass PVD
(PP)

Black chromium



Black
(NE)

9 | DOOR THICKNESS

3	Door thicknesses from 32mm up to 47mm.
4	Door thicknesses from 45mm up to 60mm.
6	Door thicknesses from 60mm up to 75mm.
7	Door thicknesses from 75mm up to 90mm.
9	Door thicknesses from 90mm up to 105mm.
1	Door thicknesses from 105mm up to 120mm.

10 | SQUARE SPINDLE

7	7mm square spindle.
8	8mm square spindle.
9	9mm square spindle.
D	7mm square spindle.
S	8mm square split spindle.
V	9mm square split spindle.
U	7mm diamond split spindle.
6	7,6mm square split spindle.

11 | HANDLE HANDING

R Right handed. Only for O or S handles.

L Left handed. Only for O or S handles.

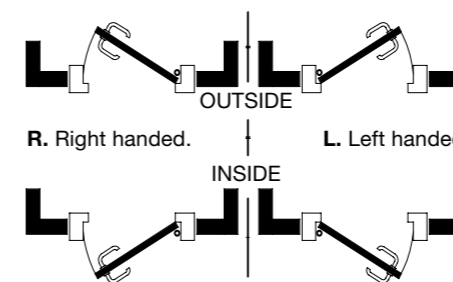

12 | WIRELESS / AMOK / KEYPAD / SALTO KS / SALLIS

C Convertible. Offline model ready to upgrade to Wireless real-time access control system.

W Wireless, for real-time access control.

A AMOK, for offline lockdown.

K Keypad. Increases security and control as it offers the choice of three forms of authentication to grant access.

Y SALTO KS by SALTO models.

S SALLIS. SALTO Lock Link System.

EX. | MODEL EXAMPLES

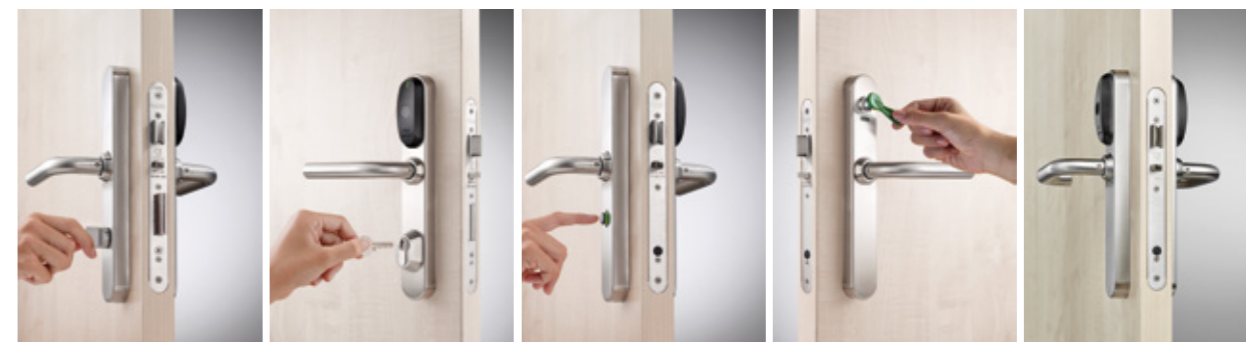

Mechanical privacy option

Key override option

Electronic privacy option

i-Button ID technology

AMOK

* Not all models allow all configurations; please refer to SALTO Systems price list to see the detail of each model.



XS4 MINI BY SALTO | ELECTRONIC DOOR LOCKS

Stylish design is a SALTO trademark and with the XS4 Mini, we raise the bar on this already high standard thanks to its small, discreet size combined with a modern, clean LED aesthetic.

TECHNICAL DATA

POWER SOURCE:

- XS4 Mini: 3 alkaline batteries - LR03 - AAA 1,5V

NUMBER OF OPENINGS:

- Contactless versions: Up to 40,000 openings.

- Low battery power indication monitored through the SALTO Virtual Network (SVN).
- The last approx. 1,000 operations are signalled.

ENVIRONMENTAL CONDITIONS:

- Not suitable for outdoor use.

MAIN FEATURES

- Fully integrated with the SALTO XS4 platform.
- Simple installation by changing handle set, using just two screws, whether installing on new or existing door standards.
- Easy to maintain: Battery change is all that's needed.
- For inside use: Attractive design is ideal for indoor use and easy to retrofit existing doors.
- User on card audit trailing capability via the SALTO Virtual Network (SVN).
- All communication between the carrier and the electronic lock is encrypted and secured.
- Low battery status information is obtained from carriers.
- Optical signalling through light ring. Dual colour green/red to indicate access authorisation.
- The lock can always be opened from the inside (single action panic feature works in conjunction with the relevant mortise lock).
- Concealed fixing screws for greater security and improved aesthetics.
- Available in 2 different reader finishes: White and Black.
- Wide range of finishes, retrofits, handles and retrofit cover plates.
- Firmware upgrade through contactless PPD.
- Emergency opening via contactless portable programming device (PPD).

The Mini's smart compactness simplifies installation. The XS4 Mini maintains the fire rating of the door as no additional drilling of the door is required.

ACCESS CONTROL FEATURES

USERS & DOORS:

- Maximum number of users per door: 4 million.
- Maximum number of doors per system: 65,000.
- Access levels: unlimited.

CALENDARS & TIME ZONES:

- Calendars in system: 256
- Timetables: 1024
- Time periods: 1024

EVENTS:

- Maximum events on lock audit: 2200.
- Non volatile memory (memory is not deleted, even if power fails).

MANAGEMENT SOFTWARE:

- SALTO ProAccess SPACE.

ID TECHNOLOGIES:

- Covering the mainstream RFID technologies.
- Compatible with ISO 14443A, ISO 14443B and ISO 15693 (Vicinity).

LOCK MODES

STANDARD:

Locked at all times.

OFFICE MODE:

Free passage.

TIMED OFFICE:

Automatic locking at end time.

AUTOMATIC OPENING:

8 pairs of "hands free" timed lock and unlocks per day with holidays.

TOGGLE:

Present card to lock, present card to unlock.

TIMED TOGGLE:

Present card to lock, present card to unlock depending on schedules.

XS4 MINI - EU / DIN

Ex150 | XS4 MINI FOR EUROPEAN MORTISE LOCKS

The XS4 Mini for European DIN mortise locks has been designed with the requirements of DIN 18251 standard doors prepared for DIN 18250 standard mortise locks, and is compatible with the DIN 18251 standard fixing instructions.



TECHNICAL CHARACTERISTICS:

- Covers door thicknesses: From 35mm up to 120mm.
- Dimensions: 127mm x 58,5mm x 22,5mm.
- Reversible handle, left or right electronic lock.
- Clutch mechanism escutcheon; when unlocked handle moves freely.
- Handle rotation: 45°.
- DIN 18251 standard prepared for DIN 18251 standard doors prepared for DIN 18250 standard mortise locks.
- Initial max. 4° pre-turn. SALTO recommends the use of a mortise lock with a maximum 4° pre-turn.
- Compatible with European profile cylinders.
- Handle compatibility: 16mm Ø.
- Square spindles available: 8mm, 8mm split, 9mm and 9mm split.

TECHNOLOGY PLATFORMS:



ID TECHNOLOGIES:

- MIFARE® (DESFire EV1, Plus, Ultralight C, Classic - ISO/IEC 14443).
- Bluetooth SMART (BLE) / NFC
- HID iCLASS® Seos™.

HANDLES:

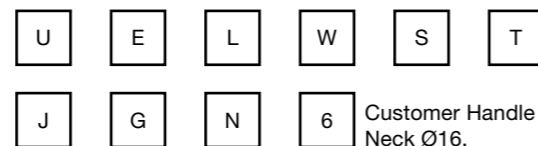

TECHNICAL DRAWING:

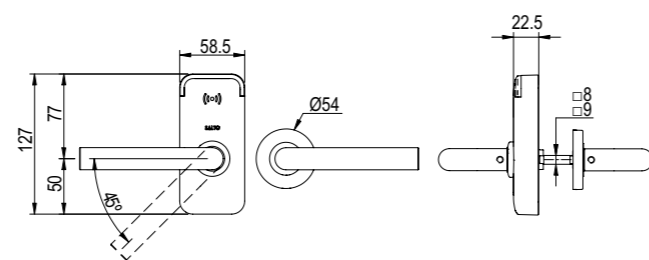

CERTIFICATIONS:



FEATURES:

- Simple installation using just two screws when installing on new or existing European / DIN door standards.
- Clear, dual colour optical signalling indicates access authorisation. Acoustic signal optional.
- High security via high resistance, hardened anti-drill protection.
- Concealed fixing screws for greater security and improved aesthetics.
- For indoor applications: quick and easy install makes it ideal for retrofits.
- Wide range of handles, configurations and door retrofit cover plates to meet the installation needs.

READER COLOUR:



FINISHES:

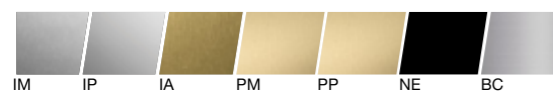

XS4 MINI - NORDIC

Sx150 | XS4 MINI FOR SCANDINAVIAN MORTISE LOCKS

The XS4 Mini Nordic models for Scandinavian mortise locks has been specially designed to fit most Scandinavian profile and narrow profile framed doors and work with standard Scandinavian mortise locks and cylinders. It is completely compatible with the Scandinavian standard fixing instructions.



TECHNICAL CHARACTERISTICS:

- Covers door thicknesses: From 35mm up to 100mm. With cover plate door thickness + 4mm.
- Dimensions: 127mm x 58,5mm x 22,5mm.
- Reversible handle, left or right electronic lock.
- Clutch mechanism escutcheon; when unlocked handle moves freely.
- Handle rotation: 45°.
- Specially designed to fit Scandinavian profile and narrow profile framed doors and work with standard Scandinavian mortise locks and cylinders.
- Completely compatible with Scandinavian standard fixing instructions and Scandinavian profile cylinders.
- Initial max. 4° pre-turn. SALTO recommends the use of a mortise lock with a maximum 4° pre-turn.
- Square spindles available: 8mm.

TECHNOLOGY PLATFORMS:



ID TECHNOLOGIES:

- MIFARE® (DESFire EV1, Plus, Ultralight C, Classic - ISO/IEC 14443).
- Bluetooth SMART (BLE) / NFC
- HID iCLASS® Seos™.

HANDLES:

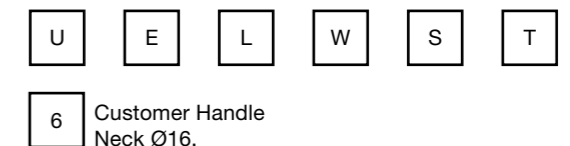

TECHNICAL DRAWING:

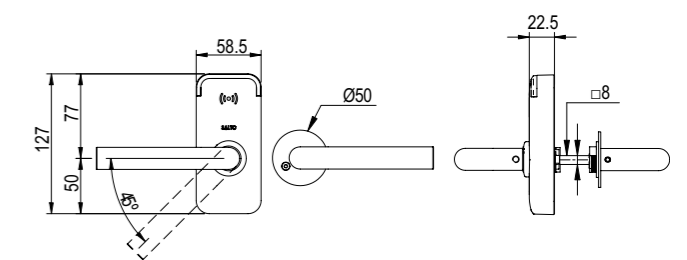

CERTIFICATIONS:



FEATURES:

- Simple installation using just two screws when installing on new or existing Scandinavian door standards.
- Clear, dual colour optical signalling indicates access authorisation. Acoustic signal optional.
- High security via high resistance, hardened anti-drill protection.
- Concealed fixing screws for greater security and improved aesthetics.
- For indoor applications: quick and easy install makes it ideal for retrofits.
- Wide range of handles, configurations and door retrofit cover plates to meet the installation needs.

READER COLOUR:



FINISHES:

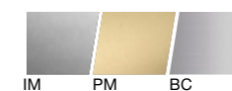

XS4 MINI - TUBULAR LATCHES

Tx150 | XS4 MINI FOR TUBULAR LATCHES

The XS4 Mini for tubular latches has been designed to be used in combination with the SALTO tubular latch model. It's an ideal way to convert a basic, interior door with a tubular latch into an attractive, electronically controlled door.



TECHNICAL CHARACTERISTICS:

- Covers door thicknesses: From 32mm up to 90mm.
- Dimensions: 127mm x 58,5mm x 22,5mm.
- Reversible handle, left or right electronic lock.
- Clutch mechanism escutcheon; when unlocked handle moves freely.
- Handle rotation: 40°.
- To be used in combination with SALTO tubular latch LT2K.
- Handle compatibility: 16mm Ø.
- Square spindles available: 7,6mm split and 8mm.

TECHNOLOGY PLATFORMS:



ID TECHNOLOGIES:

- MIFARE® (DESFire EV1, Plus, Ultralight C, Classic - ISO/IEC 14443).
- Bluetooth SMART (BLE) / NFC
- HID iCLASS® Seos™.

HANDLES:

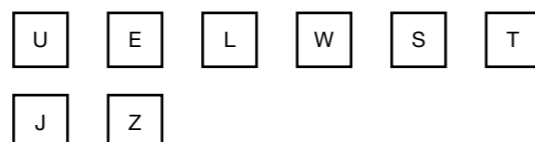

TECHNICAL DRAWING:

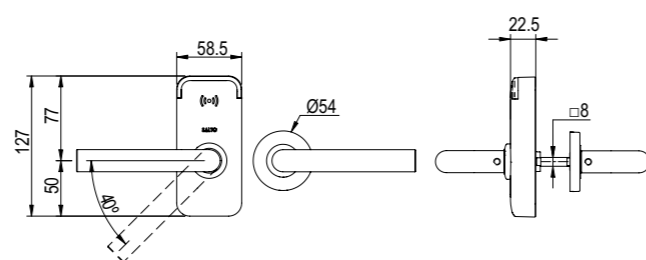

CERTIFICATIONS:



FEATURES:

- Simple installation using just two screws when installing on new or existing tubular latch door standards.
- Clear, dual colour optical signalling indicates access authorisation. Acoustic signal optional.
- High security via high resistance, hardened anti-drill protection.
- Concealed fixing screws for greater security and improved aesthetics.
- For indoor applications: quick and easy install makes it ideal for retrofits.
- Wide range of handles, configurations and door retrofit cylindrical or tubular latch cover plates, 64mm Ø to meet the installation needs.

READER COLOUR:



FINISHES:

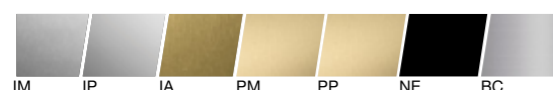

XS4 MINI - AUSTRALIA

Ux150 | XS4 MINI FOR AUSTRALIAN MORTISE LOCKS

The XS4 Mini for Australian mortise locks has been designed for use with Australian mortise locks that use split spindle systems.



TECHNICAL CHARACTERISTICS:

- Covers door thicknesses: From 32mm up to 90mm.
- Dimensions: 127mm x 58,5mm x 22,5mm.
- Reversible handle left or right electronic lock.
- Clutch mechanism escutcheon; when unlocked handle moves freely.
- Handle rotation: 45°.
- Australian standard prepared for Australian standard mortise locks.
- Initial max. 4° pre-turn. SALTO recommends the use of a mortise lock with a maximum 4° pre-turn.
- Compatible with European profile cylinders.
- Handles compatibility: 16mm Ø.
- Square spindles available: 7,6mm split, 8mm and 8mm split.

TECHNOLOGY PLATFORMS:



ID TECHNOLOGIES:

- MIFARE® (DESFire EV1, Plus, Ultralight C, Classic - ISO/IEC 14443).
- Bluetooth SMART (BLE) / NFC
- HID iCLASS® Seos™.

HANDLES:

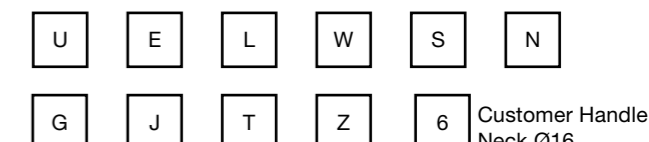

TECHNICAL DRAWING:

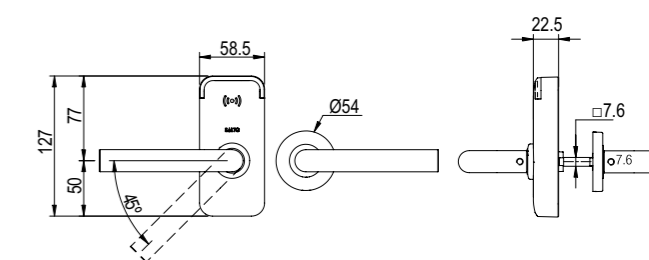

CERTIFICATIONS:



FEATURES:

- Simple installation, using just two screws when installing on new or existing Australian doors standards.
- Clear, dual colour optical signalling indicates access authorisation. Acoustic signal optional.
- High security via high resistance, hardened anti-drill protection.
- Concealed fixing screws for greater security and improved aesthetics.
- For indoor applications: quick and easy install makes it ideal for retrofits.
- Wide range of handles, configurations and door retrofit cover plates.
- Wide range of finishes, handles and retrofit cover plates to meet the installation needs.

READER COLOUR:



FINISHES:

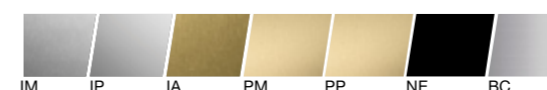

XS4 MINI - ANSI

Cx2x0 | XS4 MINI FOR CYLINDRICAL LATCH

The XS4 Mini ANSI for cylindrical or tubular latches has been designed to meet ANSI A156.2 Grade 1 or 2 cylindrical latch requirements. Easy, simple and quick way to replace existing traditional knob sets, and upgrade them with a state of the art electronic access control system with SALTO's cartridge cylindrical latch.



TECHNICAL CHARACTERISTICS:

- Covers door thicknesses: From 40mm up to 105mm (1-9/16" to 4-1/8").
- Dimensions: 127mm x 58,5mm x 22,5mm (5" x 2-19/64" x 5/8").
- Non-handed electronic lock.
- Clutch mechanism escutcheon; when unlocked handle moves freely.
- Handle rotation: 54°.
- To be used in combination with XS4 Mini ANSI's cylindrical latch only.

TECHNOLOGY PLATFORMS:



ID TECHNOLOGIES :

- MIFARE® (DESFire EV1, Plus, Ultralight C, Classic - ISO/IEC 14443).
- Bluetooth SMART (BLE).
- NFC.
- HID iCLASS® Seos™.

HANDLES:

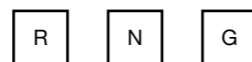

FEATURES:

- Simple installation, using just two screws when installing on new or existing ANSI cylindrical latch door standards.
- Clear, dual colour optical signalling indicates access authorisation. Acoustic signal optional.
- High security via high resistance, hardened anti-drill protection.
- Concealed fixing screws for greater security and improved aesthetics.
- For indoor applications: quick and easy install makes it ideal for retrofits.

READER COLOUR:



FINISHES:

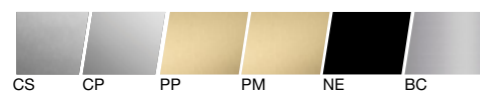

BHMA682 US26D BHMA629 US26 BHMA729 US3 BHMA732 US4 BHMA685

TECHNICAL DRAWING:

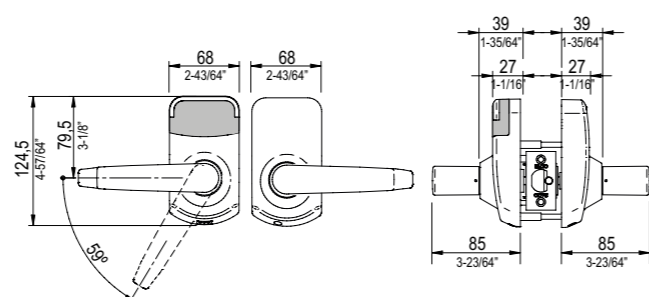

CERTIFICATIONS:

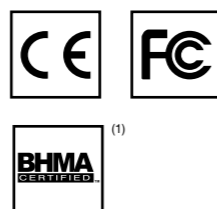

XS4 MINI - TUBULAR LATCH

Cx2x0 | XS4 MINI FOR CYLINDRICAL LATCH

The XS4 Mini ANSI for tubular latches has been designed to be used in combination with the SALTO tubular latch model. Easy, simple and quick way to replace existing traditional knob sets, and upgrade them with a state of the art electronic access control system with SALTO's tubular latch.



TECHNICAL CHARACTERISTICS:

- Covers door thicknesses: From 32mm up to 105mm (1-17/64" to 4-1/8").
- Dimensions: 127mm x 58,5mm x 22,5mm (5" x 2-19/64" x 5/8").
- Non-handed electronic lock.
- Clutch mechanism escutcheon; when unlocked handle moves freely.
- Handle rotation: 40°.
- To be used in combination with XS4 Mini ANSI's tubular latch only.

TECHNOLOGY PLATFORMS:



ID TECHNOLOGIES:

- MIFARE® (DESFire EV1, Plus, Ultralight C, Classic - ISO/IEC 14443).
- Bluetooth SMART (BLE).
- NFC.
- HID iCLASS® Seos™.

HANDLES:

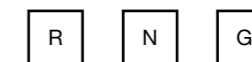

FEATURES:

- Simple installation, using just two screws when installing on new or existing ANSI cylindrical latch door standards.
- Clear, dual colour optical signalling indicates access authorisation. Acoustic signal optional.
- High security via high resistance, hardened anti-drill protection.
- Concealed fixing screws for greater security and improved aesthetics.
- For indoor applications: quick and easy install makes it ideal for retrofits.

READER COLOUR:



FINISHES:

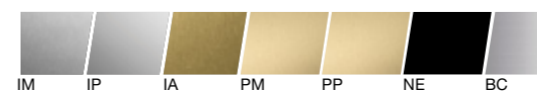

IM IP IA PM PP NE BC

TECHNICAL DRAWING:

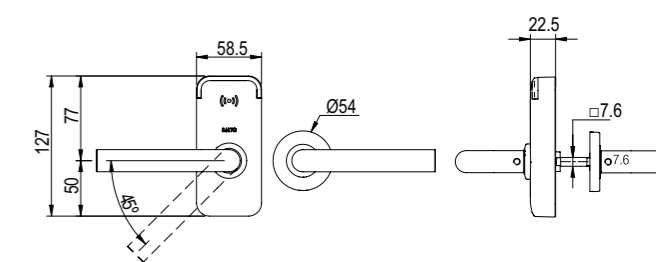

CERTIFICATIONS:

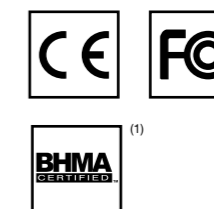

⁽¹⁾ Grade 1 according to ANSI standards

⁽¹⁾ Grade 1 according to ANSI standards

REFERENCE GUIDE INFORMATION

XS4 MINI BY SALTO | ELECTRONIC ESCUTCHEONS

Wire-free, easy to install and simple to use battery-operated electronic locking systems that can be fitted to almost any type of existing door and lock standards that are already in place anywhere for key control.

E	9	1	5	0	U	R	IM	B	3	8	R
PRODUCT TYPE	ID TECHNOLOGY	MODEL XS4 MINI	ESCUTCHEON MODEL	FUNCTION	HANDLE	ROSE	HANDLE FINISHES	READER FINISH	DOOR THICKNESS	SQUARE SPINDLE	HANDING
1	2	3	4	5	6	7	8	9	10	11	12

1 | PRODUCT TYPE

E	SALTO XS4 MINI escutcheons compatible with European mortise locks.
T	SALTO XS4 MINI escutcheons compatible with SALTO tubular latches.
S	SALTO XS4 MINI escutcheons compatible with Scandinavian mortise locks.
U	SALTO XS4 MINI escutcheons compatible with Australian mortise locks.
C	SALTO XS4 MINI escutcheon in combination with XS4 Mini ANSI cylindrical latch only.

3 | MODEL XS4 MINI

1 SALTO XS4 MINI

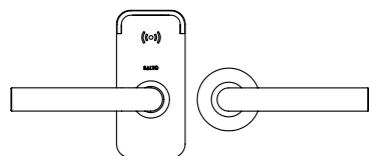

5 | FUNCTION

0	2 Handles, any type.	4	2 Handles, any type, inside plate for retrofit.
1	2 Handles, any type, inside thumbturn, with connector for mortise lock with micro-switch.	5	2 Handles, any type, special rose for retrofit.

2 | ID TECHNOLOGY

RFID	
9	Contactless MIFARE® (DESFire EV1, Plus, Ultralight C, Classic - ISO/IEC 14443).
B	Contactless BLE & MIFARE DESFire.
J	HID iCLASS® Seos™.

4 | ESCUTCHEON MODEL

5	Clutch.
6	Clutch + cover plate.

6 | HANDLE

XS4 MINI offers a wide choice of functional and stylishly designed handles suitable for use on any type of door. Many of the lever handles have been designed to meet the latest DDA (Disability Discrimination Act) requirements, ensuring they are simple and easy to operate.

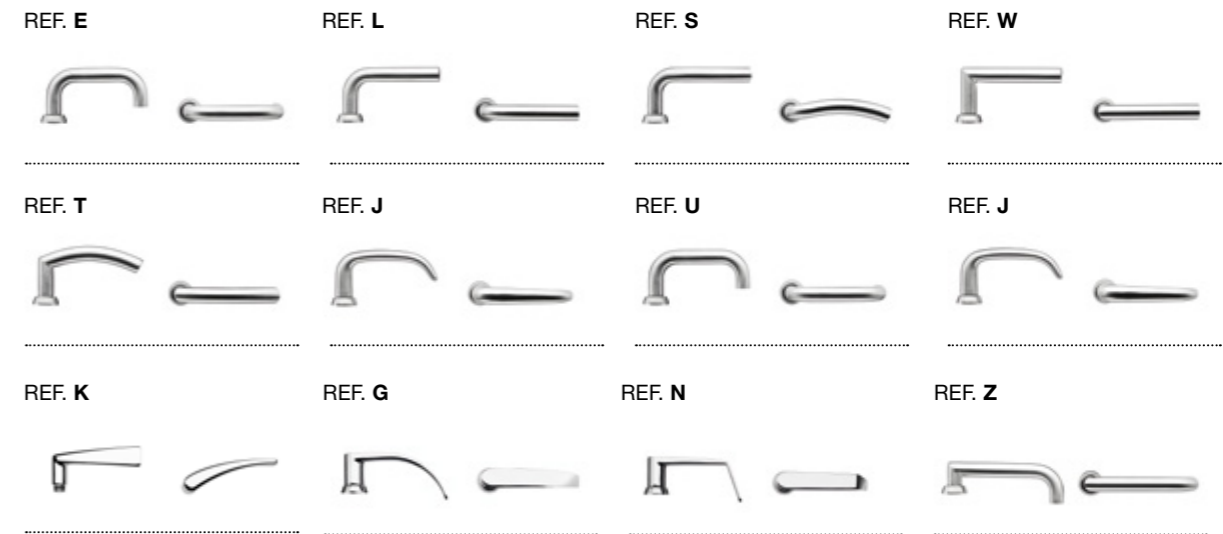

7 | ROSE

SALTO offers a wide range of handles, and all of them incorporate an inside round rose that can be customized through the wide range of finishes available.

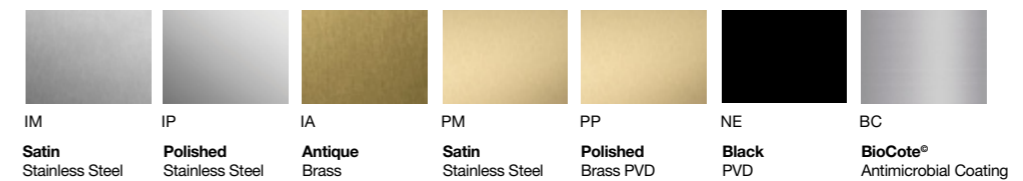

8 | FINISHES

Various finish options are available to allow for contemporary or classic styling to match any taste or design in décor, and to help in DDA impaired vision requirements.

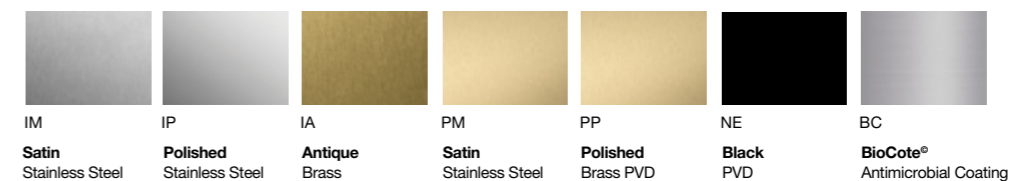

9 | READER FINISHES

Two reader finish options are available to be able to combine with all the environments, no matter the design. BioCote antimicrobial finish is also available to secure and control even the cleanest areas.

W White reader finish



B Black reader finish



10 | DOOR THICKNESS

- 3 Door thicknesses from 35mm up to 50mm.
- 4 Door thicknesses from 47mm up to 60mm.
- 6 Door thicknesses from 67mm up to 80mm.
- 7 Door thicknesses from 77mm up to 90mm.
- 9 Door thicknesses from 87mm up to 105mm.

11 | SQUARE SPINDLE

- 8 8mm square spindle.
- 9 9mm square spindle.
- 6 7,6mm square split spindle.

12 | HANDLE HANDING

R Right handed. Only for O or S handles.

L Left handed. Only for O or S handles.

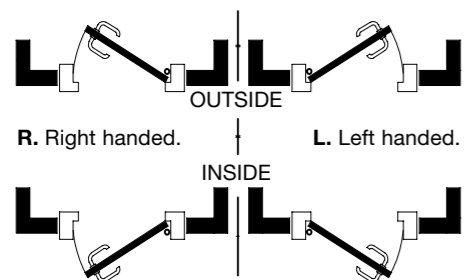

EX. | MODEL EXAMPLES

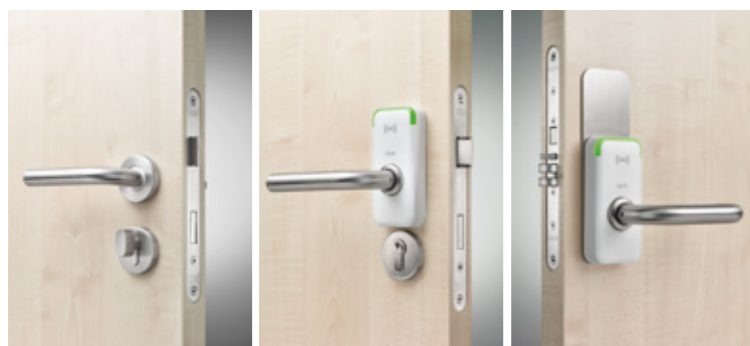

Inside thumbturn

Key override option

Cover plates option

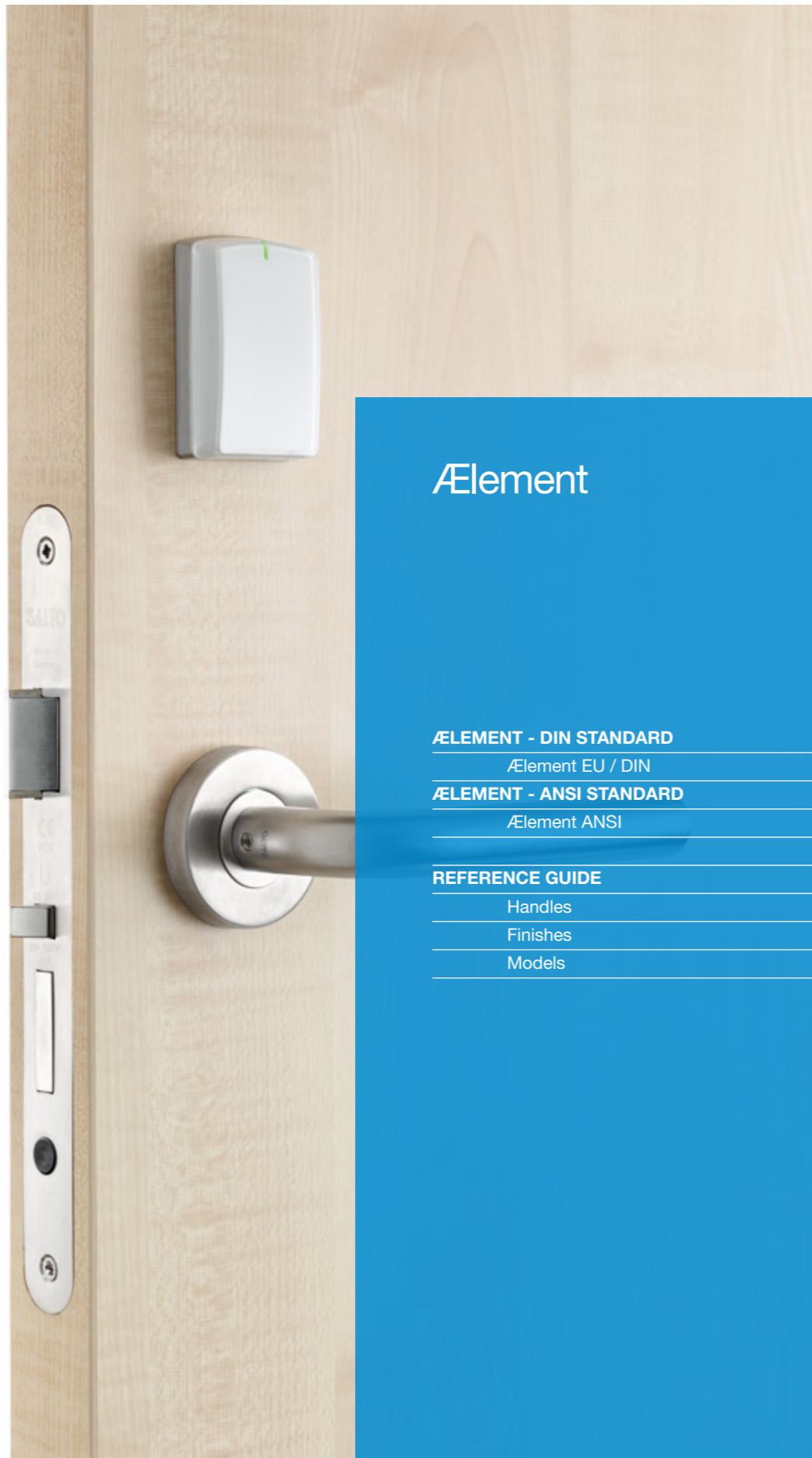

Ælement

ÆLEMENT - DIN STANDARD

Ælement EU / DIN

ÆLEMENT - ANSI STANDARD

Ælement ANSI

REFERENCE GUIDE

Handles

Finishes

Models

ÆLEMENT BY SALTO | STYLISH LOCKS

The ÆElement is an RFID lock that allows you to integrate all your physical security needs into one stylish, energy efficient, reliable, wire-free system.

TECHNICAL DATA

POWER SOURCE:

- ÆElement: 3 alkaline batteries - LR03 - AAA 1,5V.

NUMBER OF OPENINGS:

- Contactless versions: Up to 50,000 openings.
- Low battery power indication monitored through the SALTO Virtual Network (SVN).
- The last approx. 1,000 operations are signalled.

ENVIRONMENTAL CONDITIONS:

- Electronics: 0° / 60°.
- Not suitable for outdoor use.

MAIN FEATURES

- Easy to maintain: Battery change is all that's needed.
- SALTO SVN and SALTO Wireless network capable.
- Wireless ready lock that can be upgraded to wireless online.
- Handle block mechanism lock.
- To be used only with SALTO ÆElement mortise lock series.
- Compatible with DIN standard and ANSI mortise locks.
- Reader body made using double layered injection construction.
- Electronic privacy system. By pressing a button on the battery holder on European models, the user can activate the "do not disturb" function.
- The lock can always be opened from the inside (single action panic feature works in conjunction with the SALTO mortise lock).
- Clear dual colour LED light (green/red) to indicate lock authorisation.
- Concealed fixing screws for greater security and improved aesthetics.
- Wire-free stand-alone networked system through SVN technology.
- Attractive range of standard handle designs and finishes, designer lever handles from well-known brands approved.
- DDA (Disability Discrimination Act) compliant (depending on handle type).
- Emergency opening via contactless Portable Programming Device (PPD).

The minimalistic design of its RFID reader looks chic and discreet on any door, and can be combined with a wide range of either SALTO or designer handles.

ACCESS CONTROL FEATURES

USERS & DOORS:

- Maximum number of users per door: 4 million.
- Maximum number of doors per system: 65,000.
- Access levels: unlimited.

CALENDARS & TIME ZONES:

- Calendars in system: 256
- Timetables: 1024
- Time periods: 1024

EVENTS:

- Maximum events on lock audit: 2200.
- Non volatile memory (memory is not deleted, even if power fails).

MANAGEMENT SOFTWARE:

- SALTO ProAccess SPACE.

ID TECHNOLOGIES:

- Covering the mainstream MIFARE RFID technologies.
- Compatible with ISO 14443A, ISO 14443B and ISO 15693 (Vicinity).

LOCK MODES

STANDARD:

Locked at all times.

AUTOMATIC OPENING:

8 pairs of "hands free" timed lock and unlocks per day with holidays.

TOGGLE:

Present card to lock, present card to unlock.

TIMED TOGGLE:

Present card to lock, present card to unlock depending on schedules.

OFFICE MODE:

Free passage mode (just on the ANSI version).

EXIT LEAVES OPEN MODE:

The lock remains unlocked after the inside handle is used.

ÆLEMENT - EU

AE91 | ÆLEMENT

The Ælement EURO version is specially designed to fit on most Euro DIN 18250 profile doors. The minimalistic design of the RFID reader looks stylish and discreet on any door. It also offers the choice of a wide range of designer lever handles and finishes.



TECHNICAL CHARACTERISTICS:

- Covers door thicknesses: From 35mm - 45mm up to 115mm - 125mm.
- Reader dimensions: 67mm x 45mm x 17mm.
- Battery pack dimensions (inside): 116mm x 65mm x 25.5mm.
- Handle block mechanism lock.
- Handle rotation: 33°.
- To be used in combination with SALTO LE7E37 mortise lock.
- Square spindles available: 8mm split and 9mm split (SALTO spindles required).

TECHNOLOGY PLATFORMS:



ID TECHNOLOGIES:

- MIFARE® (DESFire EV1, Plus, Ultralight C, Classic - ISO/IEC 14443).
- Bluetooth SMART (BLE).
- NFC.

TECHNICAL DRAWING:

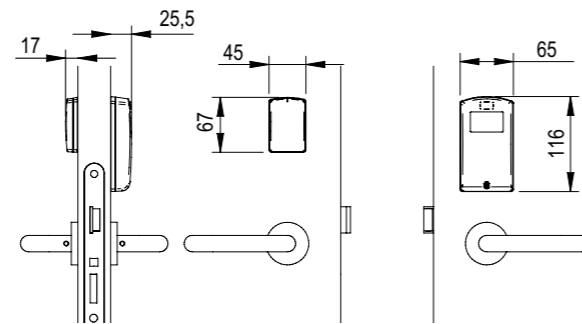

DIN18250 ÆLEMENT MORTISE LOCK:

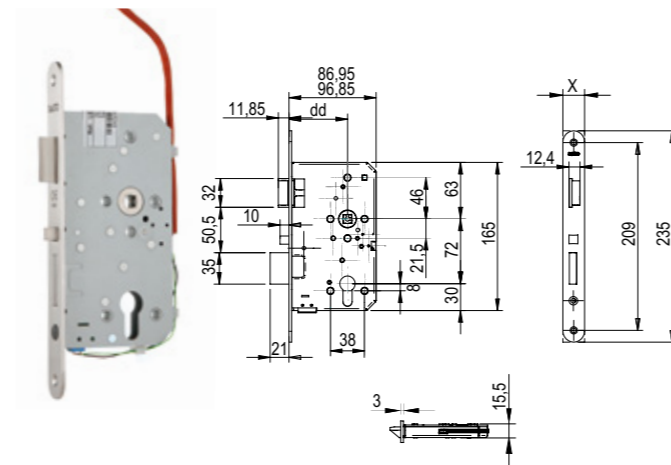

MORTISE LOCKS FEATURES:

- Axe distance 72mm.
- Lock latched deadbolt made of steel.
- Automatic deadbolt projection lock.
- Choice of finishes: satin stainless steel or gold enamelled.
- Front plate shape: square or round.
- Different backsets available: 55mm - 65mm.
- Handed lock - L/R - not reversible.
- Inside always allows free egress (Anti-panic in combination with lock).
- EN 12209 compliant.



ELECTRONICS FEATURES:

- Reader body made using double layered injection construction.
- Clear dual colour LED light (green/red) to indicate lock authorisation.
- Electronic privacy function option through button on the inside (for hotel industry). The user can activate the "do not disturb" function.
- Special blink and beep indication when lock is in privacy mode.
- Ability to enable/disable the acoustic signal.
- Compatible with European DIN 18250 mortise lock retrofit.
- EN1364-1 EI 60.
- Declaration of conformity CE.
- FCC/IC conformity.

READER COLOUR:



BASE FRAME FINISHES:

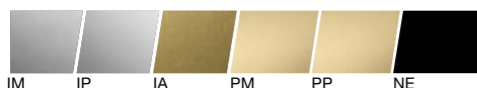

IM IP IA PM PP NE

ÆLEMENT - ANSI

AE90 | ÆLEMENT

The Ælement ANSI version is specially designed to fit on most ANSI A 156.13 doors. The minimalistic design of the RFID reader looks stylish and discreet on any door. It also offers the choice of a wide range of designer lever handles and finishes.



TECHNICAL CHARACTERISTICS:

- Covers door thicknesses: From 35mm - 45mm up to 115mm - 125mm.
- Reader dimensions: 67mm x 45mm x 17mm.
- Battery pack dimensions (inside): 116mm x 65mm x 25.5mm.
- Handle block mechanism lock.
- Handle rotation: 52°.
- To be used in combination with SALTO LA1T17 mortise lock.
- Square spindles available: 8mm split (SALTO spindles required).

TECHNOLOGY PLATFORMS:



ID TECHNOLOGIES:

- MIFARE® (DESFire EV1, Plus, Ultralight C, Classic - ISO/IEC 14443).
- Bluetooth SMART (BLE).
- NFC.

TECHNICAL DRAWING:

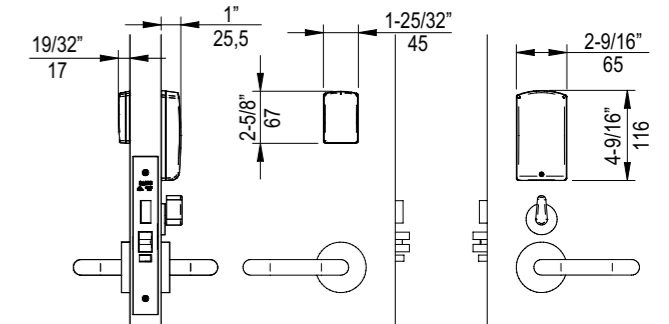

ANSI A 125.13 ÆLEMENT MORTISE LOCK:

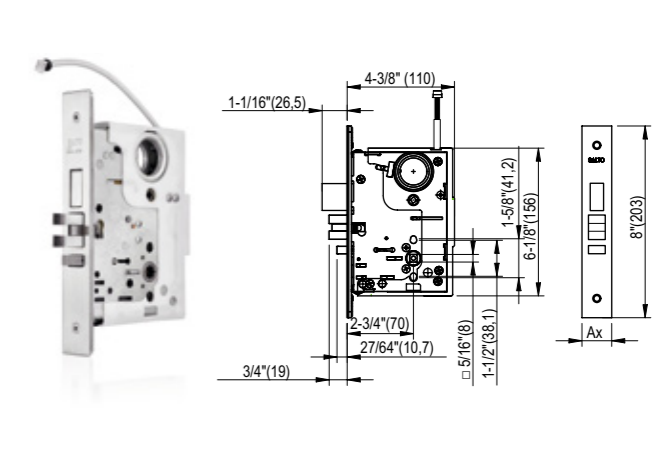

ELECTRONICS FEATURES:

- Reader body made using double layered injection construction.
- Clear dual colour LED light (green/red) to indicate lock authorisation.
- Mechanical privacy option by a mechanical thumbturn. The user can activate the "do not disturb" function just by operating this thumbturn.
- Special blink and beep indication when lock is in privacy mode.
- Ability to enable/disable the acoustic signal.
- Available with mechanical cylinder key override or access lock outs (override mortise cylinders).
- Compatible with ANSI A 125.13. mortise lock retrofit.
- UL10C compliant.
- Declaration of conformity CE.
- FCC/IC conformity.

READER COLOUR:



BASE FRAME FINISHES:

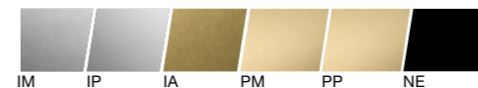

IM IP IA PM PP NE

MORTISE LOCKS FEATURES:

- Mortise lock with built in door detector, privacy detector and mechanical key override detector.
- Axe distance 62mm.
- Lock latched deadbolt made of steel.
- Choice of finishes: satin stainless steel or gold enamelled.
- Front plate shape: square.
- Handed lock - L/R - reversible.
- Inside always allows free egress (Anti-panic in combination with lock).
- UL 10C listed (90 min).



REFERENCE GUIDE INFORMATION

ÆLEMENT BY SALTO | STYLISH LOCKS

Wire-free, easy to install and simple to use battery-operated electronic locking systems that can be fitted to almost any type of existing door and lock standards that are already in place anywhere for key control.

Ælement by SALTO is an electronic lock composed of three main components that need to be purchased separately:

- The Ælement ELECTRONICS.
- The Ælement MORTISE LOCK.
- The Ælement HANDLE selection.

ÆLEMENT ELECTRONICS:

AE	9	1	IM	B	A	3	A	8	W
—	—	—	—	—	—	—	—	—	—
PRODUCT TYPE	ID TECHNOLOGY	PRIVACY FUNCTION	BASE FRAME FINISH	READER FINISH	BATTERY PACK COLOUR	DOOR THICKNESS	LOCK DESCENTRATION	SPLIT SPINDLE	WIRELESS
1	2	3	4	5	6	7	8	9	10

1 | PRODUCT TYPE

AE SALTO Ælement electronic lock.

2 | ID TECHNOLOGY

RFID

- 9 Contactless MIFARE DESFire.
- B Contactless BLE & MIFARE DESFire.
- J HID iCLASS® Seos™.

3 | PRIVACY FUNCTION

- 0 Without electronic privacy function.
- 1 With electronic privacy function.

4 | BASE FRAME FINISH

- IM Satin stainless steel (BHMA630 - US32D).
- IP Bright stainless steel (BHMA629 - US32).
- IA Antique brass(BHMA638-USS).
- PP PVD bright brass type (US3).
- PM PVD satin brass type (US4).
- NE Black chromium.

5 | READER FINISH

- B Black 
- W White 

6 | BATTERY PACK COLOUR

- W White.
- A Anthracite (RAL 7016).
- C Champagne (like the ESD).
- I Iron blue (like the ESD).

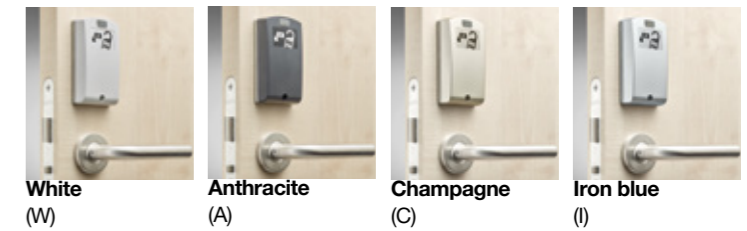

7 | DOOR THICKNESS

- 3 Door thicknesses from 35mm up to 50mm.
- 4 Door thicknesses from 45mm up to 55mm.
- 5 Door thicknesses from 55mm up to 65mm.
- 6 Door thicknesses from 65mm up to 75mm.
- 7 Door thicknesses from 75mm up to 85mm.
- 8 Door thicknesses from 85mm up to 95mm.
- 9 Door thicknesses from 95mm up to 105mm.
- 0 Door thicknesses from 105mm up to 105mm.
- 1 Door thicknesses from 115mm up to 125mm.

8 | LOCK DESCENTRATION

Please refer to the price list for more information about mortise lock vertical descentration.

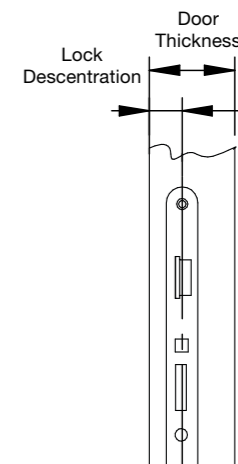

9 | SPLIT SPINDLE

- 8 8mm split spindle.
- 9 9mm split spindle.

10 | WIRELESS

- Wireless ready with data-on-card capabilities.
- W Wireless online with data-on-card capabilities.

ÆLEMENT BY SALTO | HANDLES

Ælement offers a wide choice of functional and stylish handle designs and roses suitable for use on any type of door. Various finish options are available to allow for contemporary or classic styling and to perfectly complement any design and décor.

And to go further in design, Ælement can be combined with designer handles like Colombo. Colombo by SALTO is the perfect choice when a distinctive design flair is needed.

ÆLEMENT HANDLES:

R	1	S	U	R	IM	08	0	-
PRODUCT TYPE	HANDLE STANDARD	HANDLE BRAND	MODEL	ROSE	FINISH	SQUARE SPINDLE	THUMBTURN	HANDING
1	2	3	4	5	6	7	8	9

1 | PRODUCT TYPE

R Door handles on rose.

2 | HANDLE STANDARD

1 EURO / DIN standard.
3 ANSI standard.

3 | MANUFACTURER / HANDLE BRAND

S SALTO.

C COLOMBO.

4 | HANDLE MODEL

STANDARD Line:

London:



REF. L

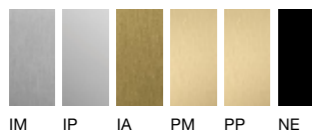

Utrecht:



REF. U

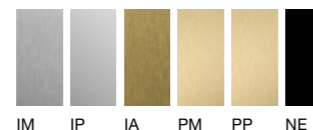

Washington:



REF. W

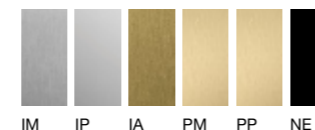

4 | HANDLE MODEL

PREMIUM Line:

Kingston:



REF. K

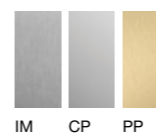

Jakarta:



REF. J

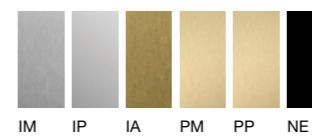

Ottawa:



REF. O

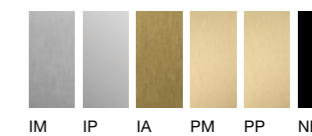

LUXURY Line: COLOMBO by SALTO:

Robodue:



REF. 2

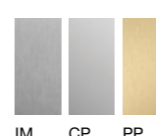

Robotre:



REF. 3

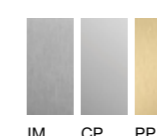

Roboquattro:



REF. 4

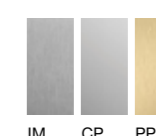

Mach:



REF. 7

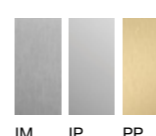

5 | ROSE

R Round rose door handle.

7 | SQUARE SPINDLE

08 8mm.

09 9mm (Only EURO / DIN models).

8 | THUMBTURN

0 Without thumbturn.

1 SALTO type thumbturn.

6 | FINISH



IM Satin Stainless Steel IP Polished Stainless Steel CP Polished Chromium

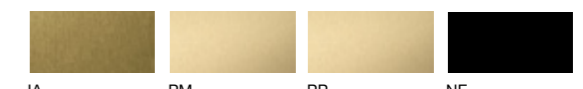

IA Antique Brass PM Satin Stainless Steel PP Polished Brass PVD NE Black PVD

9 | HANDLE HANDING

- No handing.

L / R Left hand / right hand.

ÆLEMENT BY SALTO | MORTISE LOCK

Ælement requires a good, reliable door locking system. SALTO offers a wide range of mortise locks in order to ensure that the door is correctly locked.

LE	7	E	3	7	55	R	4	1	IM	8	-
PRODUCT TYPE	FORMAT	MODEL	DEADBOLT FUNCTION	LATCH FUNCTION	BACKSET	FOREND FORM	FOREND WIDTH	DETECTOR	FINISH	SQUARE SPINDLE	HANDING
1	2	3	4	5	6	7	8	9	10	11	12

1 | PRODUCT TYPE

- LE European lock.
- LA ANSI lock.

3 | MODEL

- E For European mortise lock Ælement model.
- T For ANSI mortise lock Ælement model.

5 | LATCH FUNCTION

- 7 Spindle block mechanism.

2 | FORMAT

- 7 72 MM (for European mortise lock).
- 1 Gr 1 (for ANSI mortise lock).

4 | DEADBOLT FUNCTION

- 0 Without deadbolt.
- 1 Deadbolt + panic function.
- 3 Automatic deadbolt.

6 | BACKSET

- 55 55mm.
- 65 65mm.
- 70 70mm.

7 | FOREND FORM

- R Round.
- C Squared.
- A ANSI.

9 | DETECTOR

- 1 Privacy detection.
- 4 Handle, privacy, door status and key override detection.

11 | SQUARE SPINDLE

- S 8mm split.
- V 9mm split.

8 | FOREND WIDTH

- 0 20mm (EURO).
- 4 24mm (EURO).
- 2 32mm (ANSI).
- 7 27mm (ANSI).

10 | FINISH

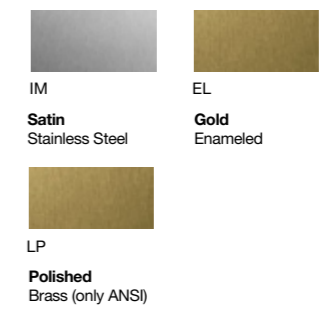

12 | HANDING

- LH Left hand.
- RH Right hand.
- LR Left hand reverse.
- RR Right hand reverse.

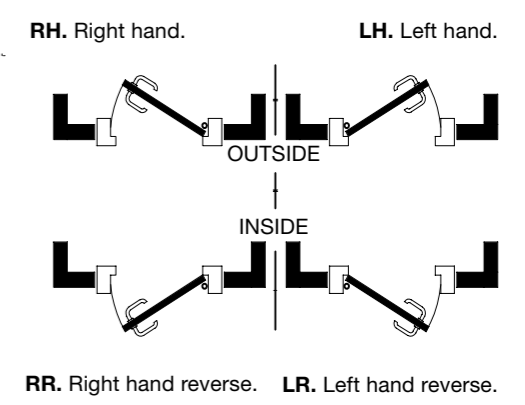



Ælement Fusion

ÆLEMENT FUSION - ANSI STANDARD

Ælement Fusion ANSI

REFERENCE GUIDE

Handles

Finishes

Models

ÆLEMENT FUSION BY SALTO | STYLISH LOCKS

Ælement Fusion is an electronic lock with a sleek reader accentuated by an interactive light ring that illuminates when access credentials are presented, providing a minimalistic design that blends with any hotel décor.

TECHNICAL DATA

POWER SOURCE:

- Ælement Fusion: 3 alkaline batteries - LR06 - AAA 1,5V.

NUMBER OF OPENINGS:

- Up to 50,000 openings.
- Low battery power indication monitored through the SALTO Virtual Network (SVN).
- The last 1,000 operations are signalled.

ENVIRONMENTAL CONDITIONS:

- Electronics: 0° / 60°.
- Not suitable for outdoor use.

MAIN FEATURES

- Easy to maintain: Battery change is all that's needed.
- Wire-free stand-alone networked system through SVN technology.
- SALTO SVN and SALTO BLUEnet network capable.
- Wireless ready lock that can be upgraded to BLUEnet online.
- Handle block mechanism lock.
- To be used only with SALTO ANSI Ælement mortise lock series.
- Clean, minimalistic round light ring design reader.
- Clear dual colour LED light (green/red) to indicate lock authorisation.
- Eliminates lock hardware on the door by encasing all electronic components inside the door itself.
- The lock can always be opened from the inside (single action panic feature works in conjunction with the SALTO mortise lock).
- Concealed fixing screws and electronic lock components within the door for greater security and improved aesthetics.
- Attractive range of standard handle designs and finishes, designer lever handles from well-known brands approved.
- DDA (Disability Discrimination Act) compliant (depending on handle type).
- Emergency opening via contactless Portable Programming Device (PPD).

ACCESS CONTROL FEATURES

USERS & DOORS:

- Maximum number of users per door: 4 million.
- Maximum number of doors per system: 65,000.
- Access levels: unlimited.

CALENDARS & TIME ZONES:

- Calendars in system: 256
- Timetables: 1024
- Time periods: 1024

EVENTS:

- Maximum events on lock audit: 2200.
- Non volatile memory (memory is not deleted, even if power fails).

MANAGEMENT SOFTWARE:

- SALTO ProAccess SPACE.

ID TECHNOLOGIES:

- Covering the mainstream RFID technologies.
- Compatible with ISO 14443A and ISO 15693 (Vicinity).

LOCK MODES

STANDARD:

Locked at all times.

AUTOMATIC OPENING:

8 pairs of "hands free" timed lock and unlocks per day with holidays.

TOGGLE:

Present card to lock, present card to unlock.

TIMED TOGGLE:

Present card to lock, present card to unlock depending on schedules.

OFFICE MODE:

Free passage mode (just on the ANSI version).

EXIT LEAVES OPEN MODE:

The lock remains unlocked after the inside handle is used.



ÆLEMENT FUSION - ANSI

AFx2 | ÆLEMENT FUSION

The Ælement Fusion's small, customizable light ring reader offers a discreet electronic lock for any type of building looking to deploy electronic access control with a stylish, yet technologically-advanced solution. SALTO offers a variety of door handles and finishes to complement any door style. The Ælement Fusion ANSI version is specially designed to fit on ANSI standards profile doors.



ELECTRONICS FEATURES:

- SALTO's stand-alone, battery powered electronic lock and technology, SVN data-on-card and advanced wireless technology with online, real-time capabilities.
- Eliminates lock hardware on the door by encasing all electronic components and battery pack inside the door itself.
- Clean, minimalistic new round light ring design reader.
- Clear dual colour round ring LED light (green/red) to indicate lock authorisation.
- Mechanical privacy option by a mechanical thumbturn. The user can activate the "do not disturb" function just by operating this thumbturn.
- Special blink and beep indication when lock is in privacy mode.
- Declaration of conformity CE.
- FCC/IC conformity.

READER COLOUR:



FRONT PLATE FINISHES:

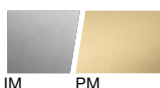

TECHNICAL CHARACTERISTICS:

- Covers door thicknesses: From 45mm up to 70mm.⁽¹⁾
- Reader dimensions (H x W x D): 45mm x 45mm x 8mm.
- Faceplate dimensions (H x W): 152mm x 31,5mm.
- Handle block mechanism lock.
- Handle rotation: 52°.
- To be used in combination with SALTO LA1T17 mortise lock.
- Square spindles available: 8mm split (SALTO spindles required).

TECHNOLOGY PLATFORMS:



ID TECHNOLOGIES :

- MIFARE® (DESFire EV1, Plus, Ultralight C, Classic - ISO/IEC 14443).
- Bluetooth SMART (BLE).
- NFC.
- HID iCLASS® Seos™.

TECHNICAL DRAWING:

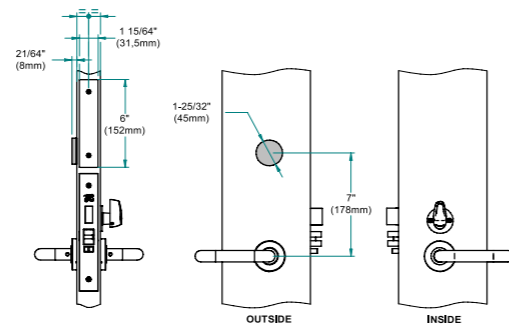

ANSI ÆLEMENT FUSION MORTISE LOCK:

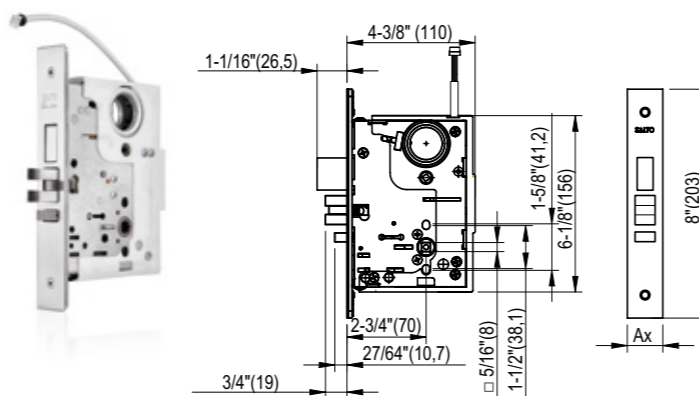

MORTISE LOCKS FEATURES:

- Mortise lock with built in door detector, privacy detector and mechanical key override detector.
- Axe distance 62mm.
- Lock latched deadbolt made of steel.
- Choice of finishes: satin stainless steel or gold enamelled.
- Front plate shape: square.
- Handed lock - L/R - reversible.
- Inside always allows free egress (Anti-panic in combination with lock).
- UL 10C listed (45 min).
- EN1634 EI60



REFERENCE GUIDE INFORMATION

ÆLEMENT FUSION BY SALTO | STYLISH LOCKS

Eliminates lock hardware on the door by encasing all electronic components inside the door itself, making security virtually invisible.

Ælement by SALTO is an electronic lock composed of three main components that need to be purchased separately:

- The Ælement ELECTRONICS.
- The Ælement MORTISE LOCK.
- The Ælement HANDLE selection.

ÆLEMENT ELECTRONICS:

AF	B	2	IM	B	3	A	8
PRODUCT TYPE	ID TECHNOLOGY	CONTROL FRONT PLATE SHAPE	BASE FRONT PLATE FINISH	READER FINISH	DOOR THICKNESS	LOCK DESCENTRATION	SPLIT SPINDLE
1	2	3	4	5	6	7	8

1 | PRODUCT TYPE

AF SALTO Ælement Fusion electronics.

2 | ID TECHNOLOGY

RFID

- B Contactless BLE & Mifare.
- J Contactless BLE & HID iCLASS®.

3 | CONTROL FRONT PLATE SHAPE

- 7 ANSI 27mm (1- 1/16")
- 2 ANSI 32mm (1- 1/4")

4 | BASE FRONT PLATE FINISH

- IM Satin stainless steel (BHMA630 - US32D).
- PM PVD satin brass type (US4).

5 | READER FINISH

- B Black
- W White

6 | DOOR THICKNESS

- 3 $40 \leq t < 45\text{mm}$.
- 4 $45 \leq t < 55\text{mm}$.
- 5 $55 \leq t < 65\text{mm}$.
- 6 $65 \leq t < 70\text{mm}$.

7 | LOCK DESCENTRATION

- A $17 \leq b < 30\text{mm}$
- B $30 \leq b < 35\text{mm}$
- 0 Without spindles

8 | SPLIT SPINDLE

- 8 8mm

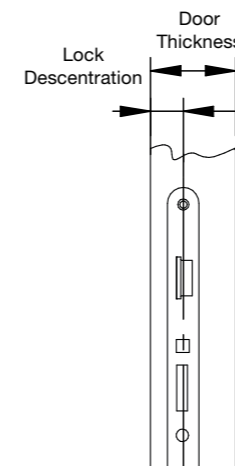

ÆLEMENT FUSION BY SALTO | HANDLES

The Ælement Fusion's small, customizable light ring reader offers a discreet electronic lock to deploy electronic access control with a stylish, yet technologically-advanced solution.

SALTO offers a variety of door handles and finishes to complement any door style. And to go further in design, Ælement can be combined with designer handles like Colombo.

ÆLEMENT HANDLES:

R	1	S	U	R	IM	08	0	-
PRODUCT TYPE	HANDLE STANDARD	HANDLE BRAND	MODEL	ROSE	FINISH	SQUARE SPINDLE	THUMBTURN	HANDING
1	2	3	4	5	6	7	8	9

1 | PRODUCT TYPE

R Door handles on rose.

2 | HANDLE STANDARD

3 ANSI standard.

3 | MANUFACTURER / HANDLE BRAND

S SALTO.

C COLOMBO.

4 | HANDLE MODEL

STANDARD Line:

London:



REF. L

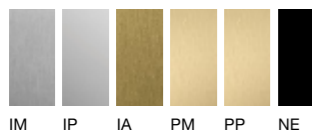

Utrecht:



REF. U

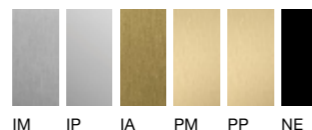

Washington:



REF. W

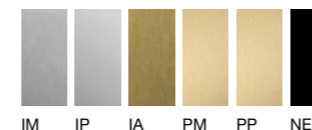

4 | HANDLE MODEL

PREMIUM Line:

Kingston:



REF. K

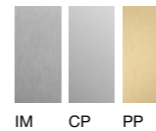

Jakarta:



REF. J

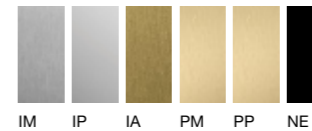

Ottawa:



REF. O

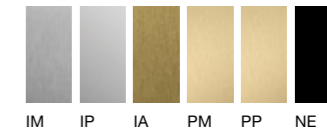

LUXURY Line: COLOMBO by SALTO:

Robodue:



REF. 2

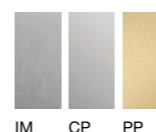

Robotre:



REF. 3

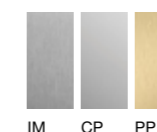

Roboquattro:



REF. 4

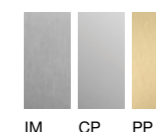

Mach:



REF. 7



5 | ROSE

R Round rose door handle.

7 | SQUARE SPINDLE

08 8mm.

8 | THUMBTURN

0 Without thumbturn.

1 SALTO type thumbturn.

6 | FINISH



IM Satin Stainless Steel IP Polished Stainless Steel CP Polished Chromium

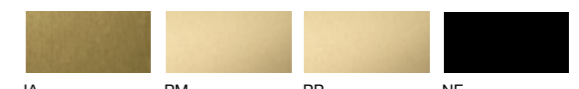

IA Antique Brass PM Satin Stainless Steel PP Polished Brass PVD NE Black PVD

9 | HANDLE HANDING

- No handing.

L / R Left hand / right hand.

ÆLEMENT FUSION BY SALTO | MORTISE LOCK

Ælement Fusion requires a good, reliable door locking system. SALTO offers a wide range of mortise locks in order to ensure that the door is correctly locked.

LA	1	T	1	7	70	F	7	4	IM	S	RH
PRODUCT TYPE	FORMAT	MODEL	DEADBOLT FUNCTION	LATCH FUNCTION	BACKSET	FOREND FORM	FOREND WIDTH	DETECTOR	FINISH	SQUARE SPINDLE	HANDING
1	2	3	4	5	6	7	8	9	10	11	12

1 | PRODUCT TYPE

LA ANSI lock.

2 | FORMAT

1 Gr 1 (for ANSI mortise lock).

3 | MODEL

T For ANSI mortise lock Ælement model.

4 | DEADBOLT FUNCTION

0 Without deadbolt.
1 Deadbolt + panic function.

5 | LATCH FUNCTION

7 Spindle block mechanism.

6 | BACKSET

70 70mm.

7 | FOREND FORM

F Squared for Ælement Fusion ANSI model

8 | FOREND WIDTH

2 32mm (ANSI).
7 27mm (ANSI).

9 | DETECTOR

1 Privacy detection.
4 Handle, privacy, door status and key override detection.

10 | FINISH

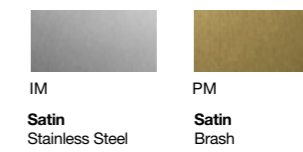

11 | SQUARE SPINDLE

S 8mm split.

12 | HANDING

LH Left hand.
RH Right hand.
LR Left hand reverse.
RR Right hand reverse.

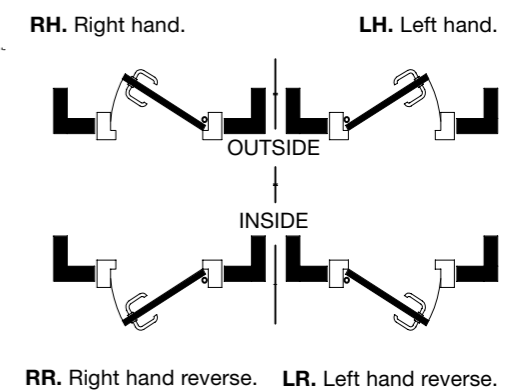



SALTO GEO Cylinders

SALTO GEO EU PROFILE CYLINDERS

- European Profile Half Cylinder
- European Profile Cylinder
- European Profile Double Cylinder

SALTO GEO SWISS PROFILE CYLINDERS

- Swiss Profile Half Cylinder
- Swiss Profile Cylinder
- Swiss Profile Double Cylinder

SALTO GEO UK PROFILE CYLINDERS

- UK Oval Profile Half Cylinder
- UK Oval Profile Cylinder
- UK Oval Profile Double Cylinder
- UK RIM Profile Cylinder

SALTO GEO SCANDINAVIAN CYLINDERS

- Scandinavian Profile External Cylinder
- Scandinavian Profile Internal Cylinder
- Scandinavian Profile Security Cylinder

SALTO GEO ANSI CYLINDERS

- ANSI Mortise Cylinder
- RIM Cylinder
- Heavy Duty Deadbolt Cylinder

SALTO GEO AUSTRALIAN OVAL CYLINDERS

SALTO GEO CYLINDERS SWING HANDLES

SALTO GEO CYLINDERS FOR CAM LOCKS

SALTO GEO ELECTRONIC PADLOCKS

REFERENCE GUIDE

- Finishes
- Models

SALTO GEO BY SALTO | ELECTRONIC CYLINDERS

Extensive range of wire-free, stand-alone electronic cylinders designed for doors where fitting an electronic escutcheon is not possible or required (e.g. antique doors).

TECHNICAL DATA

POWER SOURCE:

- 1 Lithium standard battery CR2.

NUMBER OF OPENINGS:

- i-Button version: up to 60,000 on 1 battery.
- Contactless versions: > 200.000 cycles (EN 15684 class 6).
- Low battery power indication monitored through the SALTO Virtual Network (SVN).

ENVIRONMENTAL CONDITIONS:

- XS4 GEO Electronic cylinders: -20° / 60°.

IP CERTIFICATIONS:

- Outdoor Protection Standard
- IP55* MODEL (SALTO GEO standard model).
- IP66* MODEL (SALTO GEO water resistant model [GxxxxR]).

MAIN FEATURES

- Simple installation by changing the cylinder. No wiring or drilling work required.
- Wide range of models and options.
- SALTO SVN and SALTO Wireless network capable.
- User on card audit trailing capability via the SALTO Virtual Network (SVN).
- Covering the mainstream RFID technologies.
- NFC compatible.
- All communication between the carrier and the electronic cylinder is encrypted and secured.
- Low battery status information is obtained from carriers.
- Battery replacement without cylinder removal.
- Optical signalling through light ring. Dual colour green/red to indicate access authorisation. Acoustic signal optional.
- Equipped with anti-drilling protection.
- Optional torx screw to tighten the knob and convert the cylinder on a fixed knob cylinder.
- White and black reader finishes available.
- Wide range of finishes: satin chrome, polished chrome, polished bright brass type (PVD), satin brass type (PVD), black satin.
- Available with antimicrobial BioCote® coating.
- Suitable for emergency exits.
- Firmware upgrade through PPD.
- Emergency opening via portable programming device (PPD).

* IP66 refers only to electronic knob. Water entrance through the cam is not protected.

In addition to use on doors, other applications including post boxes, server racks, cupboards or boxes can be controlled and protected by SALTO GEO electronic camlocks and padlocks against theft or unauthorized use.

ACCESS CONTROL FEATURES

USERS & DOORS:

- Maximum number of users per door: 4 million.
- Maximum number of doors per system: 65,000.
- Access levels: unlimited.

CALENDARS & TIME ZONES:

- Calendars in system: 256
- Timetables: 1024
- Time periods: 1024

EVENTS:

- Maximum events on lock audit: 2200.
- Non volatile memory (memory is not deleted, even if power fails).

MANAGEMENT SOFTWARE:

- SALTO ProAccess SPACE.

ID TECHNOLOGIES:

- Covering the mainstream RFID technologies.
- Compatible with ISO 14443A, ISO 14443B and ISO 15693 (Vicinity).

LOCK MODES

STANDARD:

Locked at all times.

AUTOMATIC OPENING:

8 pairs of "hands free" timed lock and unlocks per day with holidays.

TOGGLE:

Present card to lock, present card to unlock.

TIMED TOGGLE:

Present card to lock, present card to unlock depending on schedules.

CERTIFICATIONS

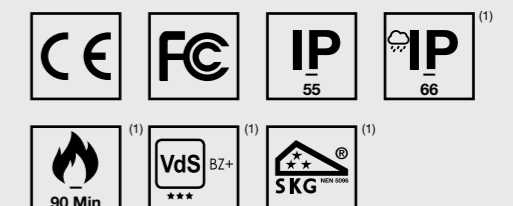

(1) Depending on the model

SALTO GEO - EU

SALTO GxE | EU EUROPEAN PROFILE CYLINDER

The SALTO GEO European cylinder is specially designed to fit most Euro doors that are equipped with a European profile cylinder mortise lock.



Half cylinder



Cylinder with thumbturn



Double reader cylinder for both entry and exit

FEATURES:

- SALTO SVN and SALTO Wireless network capable.
- All communication between the carrier and the electronic cylinder is encrypted and secured.
- The batteries can be replaced without cylinder removal.
- Optical signalling through light ring. Dual colour green/red to indicate access authorisation. Acoustic signal optional.
- Equipped with anti-drilling protection.
- Optional torx screw to tighten the knob and convert the cylinder on a fixed knob cylinder.
- Emergency opening via portable programming device (PPD).
- AMOK function adds a safe outside override even if the inside cylinder thumbturn is manually blocked.

READER COLOUR:



FINISHES:

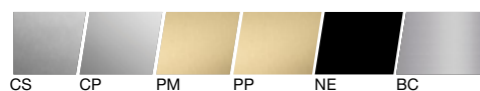

CS CP PM PP NE BC

TECHNICAL CHARACTERISTICS:

- Thickness available from 40mm up to 370mm (special body length available for glass doors).
- Plus plug options (+5mm / +10mm) for doors where cylinders need additional length between the knob and the body.
- Different cam options:
 - European profiles DIN 15mm.
 - Cog wheel: 10 tooth cam and 13 tooth cam.
 - Spain: 13,2mm for metal doors.
- Versions for glass doors available.
- Modular cylinder body assembly on standard configuration option available.
- Available with 2 different locking thumbturns on the inside to operate the cam.
- Anti-panic function available.
- AMOK function available for cylinders with thumbturn.



TECHNOLOGY PLATFORMS:

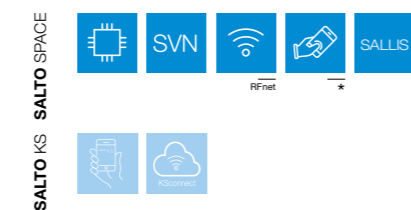

ID TECHNOLOGIES :

- MIFARE® (DESFire EV1, Plus, Ultralight C, Classic - ISO/IEC 14443).
- NFC.
- LEGIC Prime and LEGIC Advant.
- HID iCLASS®.
- i-Button.

TECHNICAL DRAWING:

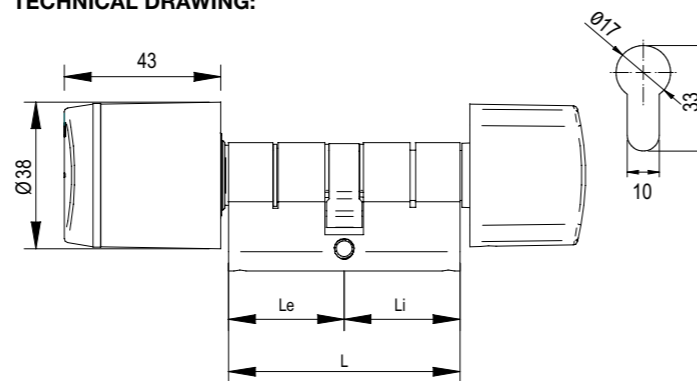

CERTIFICATIONS:

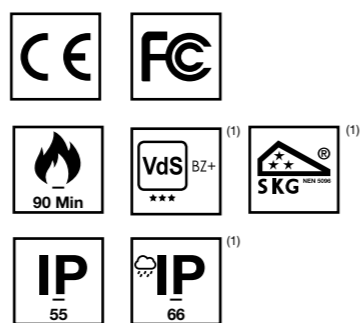

(1) Depending on the model
(*) NFC compatible smartphones only.

SALTO GEO - SWISS

SALTO GxH | SWISS PROFILE CYLINDER

The SALTO GEO Swiss profile cylinder is specially designed for doors with a Swiss round profile cylinder mortise lock.



Half cylinder



Cylinder with thumbturn



Double reader cylinder for both entry and exit

FEATURES:

- SALTO SVN and SALTO Wireless network capable.
- All communication between the carrier and the electronic cylinder is encrypted and secured.
- The batteries can be replaced without cylinder removal.
- Optical signalling through light ring. Dual colour green/red to indicate access authorisation. Acoustic signal optional.
- Equipped with anti-drilling protection.
- Optional torx screw to tighten the knob and convert the cylinder on a fixed knob cylinder.
- Emergency opening via portable programming device (PPD).
- AMOK function adds a safe outside override even if the inside cylinder thumbturn is manually blocked.

READER COLOUR:



FINISHES:

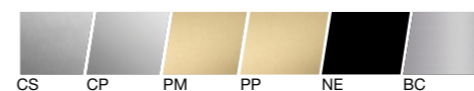

CS CP PM PP NE BC

TECHNICAL CHARACTERISTICS:

- Available from 40mm up to 370mm in thickness (special body length available for glass doors).
- Plus plug options (+5mm / +10mm) for doors where cylinders need additional length between the knob and the body.
- Different cam options:
 - Swiss 15mm.
 - Cog wheel: 10 tooth cam and 13 tooth cam.
- Versions for glass doors available.
- Available with 2 different locking thumbturns on the inside to operate the cam.
- AMOK function available for cylinders with thumbturn.



TECHNOLOGY PLATFORMS:

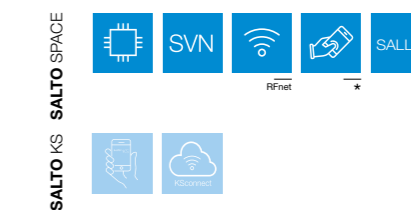

ID TECHNOLOGIES :

- MIFARE® (DESFire EV1, Plus, Ultralight C, Classic - ISO/IEC 14443).
- NFC.
- LEGIC Prime and LEGIC Advant.
- HID iCLASS®.
- i-Button.

TECHNICAL DRAWING:

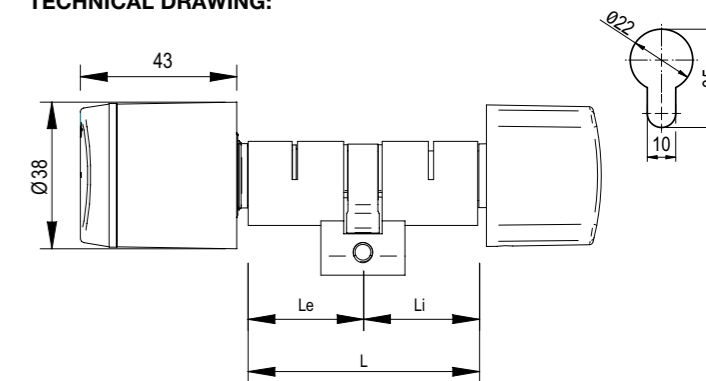

CERTIFICATIONS:



(1) Depending on the model
(*) NFC compatible smartphones only.

SALTO GEO - RIM UK

SALTO GxU | UK RIM PROFILE CYLINDER

The SALTO GEO UK RIM cylinder is specially designed to fit most doors that are equipped with surface mounted lock cases, panic bars and top guards that need this type of locking system.



FEATURES:

- SALTO SVN and SALTO Wireless network capable.
- All communication between the carrier and the electronic cylinder is encrypted and secured.
- The batteries can be replaced without cylinder removal.
- Optical signalling through light ring. Dual colour green/red to indicate access authorisation. Acoustic signal optional.
- Equipped with anti-drilling protection.
- Optional torx screw to tighten the knob and convert the cylinder on a fixed knob cylinder.
- Emergency opening via portable programming device (PPD).

READER COLOUR:



FINISHES:

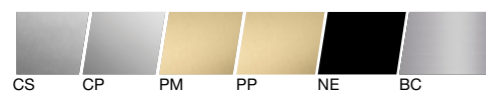

TECHNICAL CHARACTERISTICS:

- Suitable for 70mm door thickness.
- Compatible with any brand of nightlatch and provides a standard level of security.
- Standard ring, backplate and screws included.

TECHNOLOGY PLATFORMS:

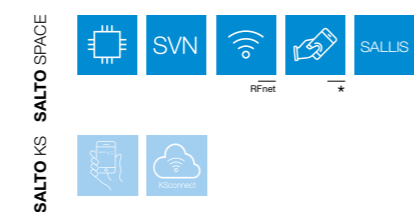

ID TECHNOLOGIES :

- MIFARE® (DESFire EV1, Plus, Ultralight C, Classic - ISO/IEC 14443).
- NFC.
- LEGIC Prime and LEGIC Advant.
- HID iCLASS®.
- i-Button.

TECHNICAL DRAWING:

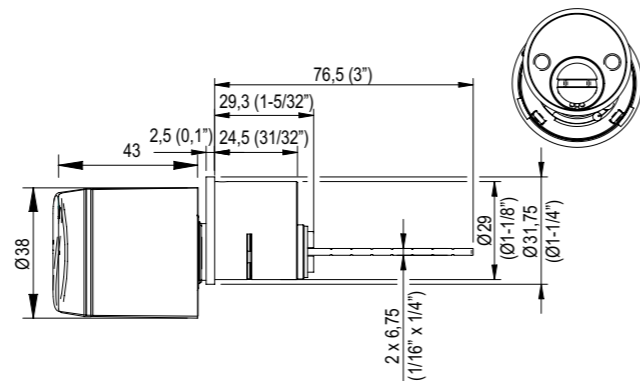

CERTIFICATIONS:

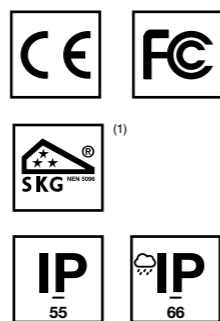

(1) Depending on the model
(*) NFC compatible smartphones only.

SALTO GEO - UK

SALTO GxU | UK OVAL PROFILE CYLINDER

The SALTO GEO UK oval cylinder is specially designed to fit most doors that are equipped with a UK profile cylinder mortise lock.



FEATURES:

- SALTO SVN and SALTO Wireless network capable.
- All communication between the carrier and the electronic cylinder is encrypted and secured.
- The batteries can be replaced without cylinder removal.
- Optical signalling through light ring. Dual colour green/red to indicate access authorisation. Acoustic signal optional.
- Equipped with anti-drilling protection.
- Optional torx screw to tighten the knob and convert the cylinder on a fixed knob cylinder.
- Emergency opening via portable programming device (PPD).

READER COLOUR:



FINISHES:

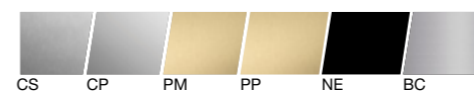

TECHNICAL CHARACTERISTICS:

- Available from 40mm up to 370mm in thickness.
- Plus plug options (+5mm / +10mm) for doors where cylinders need additional length between the knob and the body.
- Cam: UK cam 14.3mm.
- Versions for glass doors available.
- Available with 2 different locking thumbturns on the inside to operate the cam.

TECHNOLOGY PLATFORMS:

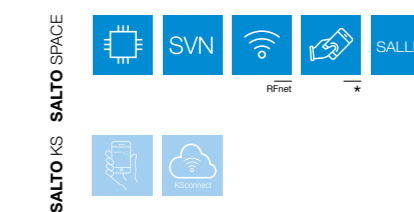

ID TECHNOLOGIES :

- MIFARE® (DESFire EV1, Plus, Ultralight C, Classic - ISO/IEC 14443).
- NFC.
- LEGIC Prime and LEGIC Advant.
- HID iCLASS®.
- i-Button.

TECHNICAL DRAWING:

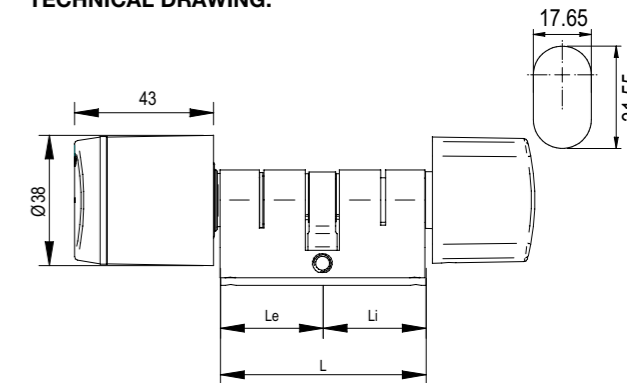

CERTIFICATIONS:



(1) Depending on the model
(*) NFC compatible smartphones only.

SALTO GEO - NORDIC

SALTO GxS | SCANDINAVIAN NORDIC PROFILE CYLINDER

The SALTO GEO Scandinavian external cylinder is specially designed to fit most doors that are equipped with a Scandinavian profile cylinder mortise lock. It can be a double reader in combination with the GxS2 (entrance & exit).



TECHNICAL CHARACTERISTICS:

- To be fitted to a standard Scandinavian standard door.
- Standard accessory sets for Scandinavian oval cylinders, secure plates protection for cylinders available.
- Can be used with most ASSA ABLOY®, ASSA / RUKO and TRIOVING lock cases.
- Different sizes of screws and cylinder rings available.
- For interior and exterior use.

TECHNOLOGY PLATFORMS:

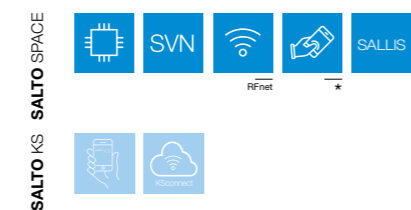

ID TECHNOLOGIES:

- MIFARE® (DESFire EV1, Plus, Ultralight C, Classic - ISO/IEC 14443).
- NFC.
- LEGIC Prime and LEGIC Advant.
- HID iCLASS®.
- i-Button.

FEATURES:

- SALTO SVN and SALTO Wireless network capable.
- All communication between the carrier and the electronic cylinder is encrypted and secured.
- The batteries can be replaced without cylinder removal.
- Optical signalling through light ring. Dual colour green/red to indicate access authorisation. Acoustic signal optional.
- Equipped with anti-drilling protection.
- Optional torx screw to tighten the knob and convert the cylinder on a fixed knob cylinder.
- Suitable for medium to high security applications.
- Emergency opening via portable programming device (PPD).

READER COLOUR:



FINISHES:

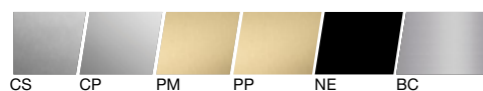

TECHNICAL DRAWING:

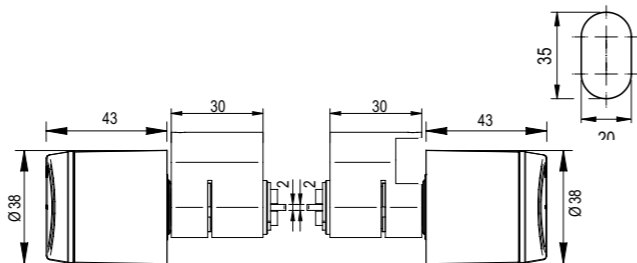

CERTIFICATIONS:

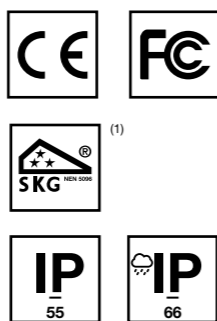

(1) Depending on the model
(*) NFC compatible smartphones only.

SALTO GEO - NORDIC

SALTO GxS | SCANDINAVIAN NORDIC PROFILE CYLINDER

The SALTO GEO Scandinavian external cylinder is specially designed to fit most doors that are equipped with a Scandinavian security external profile cylinder mortise lock.



TECHNICAL CHARACTERISTICS:

- To be fitted to a standard Scandinavian standard door.
- Standard accessory sets for Scandinavian oval cylinders, secure plates protection for cylinders available.
- Can be used with most round ASSA ABLOY®, ASSA / RUKO and TRIOVING lock cases.
- Different sizes of screws and cylinder rings available.
- For interior and exterior use.

TECHNOLOGY PLATFORMS:

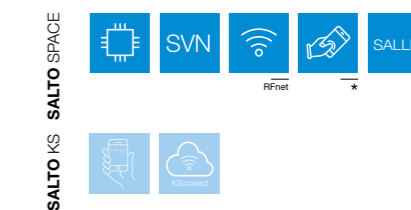

ID TECHNOLOGIES:

- MIFARE® (DESFire EV1, Plus, Ultralight C, Classic - ISO/IEC 14443).
- NFC.
- LEGIC Prime and LEGIC Advant.
- HID iCLASS®.
- i-Button.

FEATURES:

- SALTO SVN and SALTO Wireless network capable.
- All communication between the carrier and the electronic cylinder is encrypted and secured.
- The batteries can be replaced without cylinder removal.
- Optical signalling through light ring. Dual colour green/red to indicate access authorisation. Acoustic signal optional.
- Equipped with anti-drilling protection.
- Optional torx screw to tighten the knob and convert the cylinder on a fixed knob cylinder.
- Suitable for high security applications.
- Emergency opening via portable programming device (PPD).

READER COLOUR:



FINISHES:



TECHNICAL DRAWING:

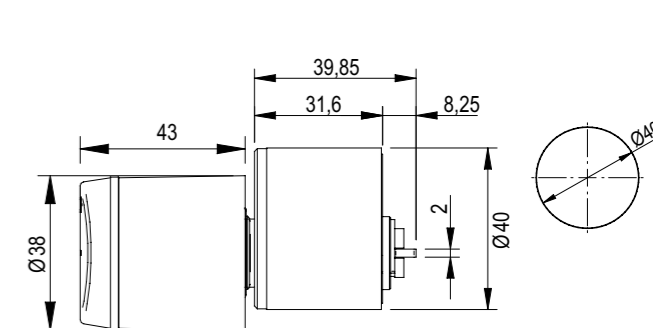

CERTIFICATIONS:



(1) Depending on the model
(*) NFC compatible smartphones only.

SALTO GEO - MORTISE

SALTO GxM | ANSI MORTISE CYLINDER

The SALTO GEO mortise cylinder is specially designed to fit most doors that are equipped with a mortise lock that need a mortise cylinder.



TECHNICAL CHARACTERISTICS:

- Available from 32mm (1-1/4") to 50mm (2") mortise lengths.
- Standard and Adams Rite cams included.
- Compatible with most market standard cams (Medeco®, Yale®, Marks®, Ilco®)
- Optional ring available for better fitting.
- Tool accessory for an accurate installation.

TECHNOLOGY PLATFORMS:

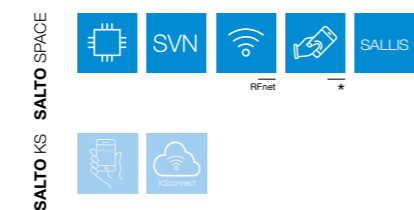

ID TECHNOLOGIES:

- MIFARE® (DESFire EV1, Plus, Ultralight C, Classic - ISO/IEC 14443).
- NFC.
- LEGIC Prime and LEGIC Advant.
- HID iCLASS®.
- i-Button.

FEATURES:

- SALTO SVN and SALTO Wireless network capable.
- All communication between the carrier and the electronic cylinder is encrypted and secured.
- The batteries can be replaced without cylinder removal.
- Optical signalling through light ring. Dual colour green/red to indicate access authorisation. Acoustic signal optional.
- Equipped with anti-drilling protection.
- Optional torx screw to tighten the knob and convert the cylinder on a fixed knob cylinder.
- Emergency opening via portable programming device (PPD).

READER COLOUR:



FINISHES:

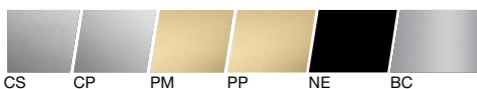

TECHNICAL DRAWING:

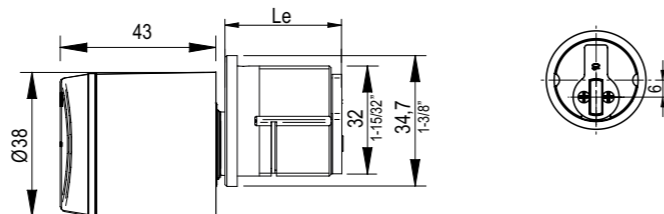

CERTIFICATIONS:

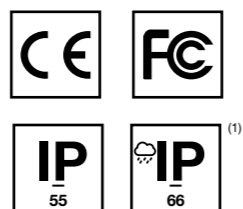

SALTO GEO - RIM US

SALTO GxB | RIM ANSI CYLINDER

The SALTO GEO RIM US cylinder is specially designed to fit most doors that are equipped with surface mounted lock cases, panic bars and top guards that need a RIM cylinder.



TECHNICAL CHARACTERISTICS:

- External cylinder, one knob.
- No thumbturn.
- Ring, backplate and screws included.
- GxB2 option for Schlage B-Series.

TECHNOLOGY PLATFORMS:

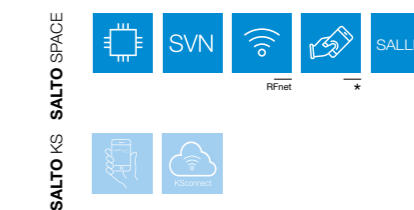

ID TECHNOLOGIES:

- MIFARE® (DESFire EV1, Plus, Ultralight C, Classic - ISO/IEC 14443).
- NFC.
- LEGIC Prime and LEGIC Advant.
- HID iCLASS®.
- i-Button.

FEATURES:

- SALTO SVN and SALTO Wireless network capable.
- All communication between the carrier and the electronic cylinder is encrypted and secured.
- The batteries can be replaced without cylinder removal.
- Optical signalling through light ring. Dual colour green/red to indicate access authorisation. Acoustic signal optional.
- Equipped with anti-drilling protection.
- Optional torx screw to tighten the knob and convert the cylinder on a fixed knob cylinder.
- Emergency opening via portable programming device (PPD).

READER COLOUR:



FINISHES:

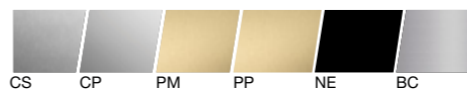

TECHNICAL DRAWING:

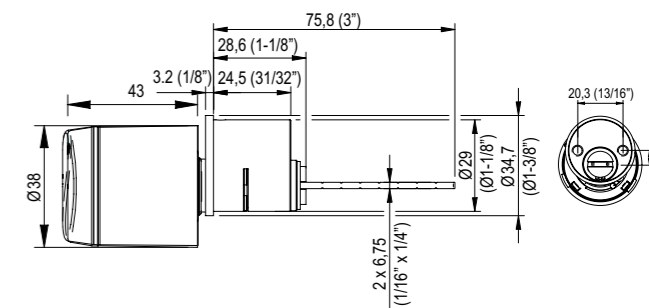

CERTIFICATIONS:

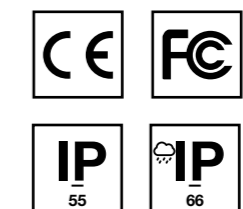

(1) Depending on the model
(*) NFC compatible smartphones only.

(1) Depending on the model
(*) NFC compatible smartphones only.

SALTO GEO - DEADBOLT

SALTO GxB | DEADBOLT CYLINDER

The SALTO GEO Deabolt cylinder model is a specially designed, heavy duty deadbolt cylinder that meets A156.36 grade 1 requirements, and also has a trim ring with protective sleeves that protect and prevent the lock from being attacked through the door. The trim ring also protects the lock from attacks coming vertically. It is designed to provide high levels of security and fit all standard doors in ANSI markets.



FEATURES:

- SALTO SVN and SALTO Wireless network capable.
- All communication between the carrier and the electronic cylinder is encrypted and secured.
- The batteries can be replaced without cylinder removal.
- Optical signalling through light ring. Dual colour green/red to indicate access authorisation. Acoustic signal optional.
- Equipped with anti-drilling protection.
- Optional torx screw to tighten the knob and convert the cylinder on a fixed knob cylinder.
- Emergency opening via portable programming device (PPD).

READER COLOUR:



FINISHES:

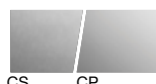

CS CP

TECHNICAL CHARACTERISTICS:

- Available from 35mm - 51mm up to 64mm in thickness.
- Trim ring with protective sleeve protects the lock from attack through the door.
- Trim ring protects lock from vertical attacks.
- Square corner strike 1-1/8" x 2-1/4" (29mm x 70mm) with dustbox.
- Heavy duty steel support plate with 3" wood screws to strengthen the wood jamb.
- Reinforced turn knob assembly.
- Available with three different functions:
 - Single cylinder.
 - Classroom style.
 - Double cylinder for both inside and outside opening with the smart credential.

TECHNOLOGY PLATFORMS:

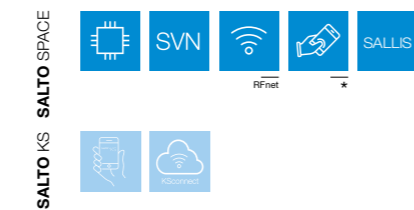

ID TECHNOLOGIES:

- MIFARE® (DESFire EV1, Plus, Ultralight C, Classic - ISO/IEC 14443).
- NFC.
- LEGIC Prime and LEGIC Advant.
- HID iCLASS®.
- i-Button.

TECHNICAL DRAWING:

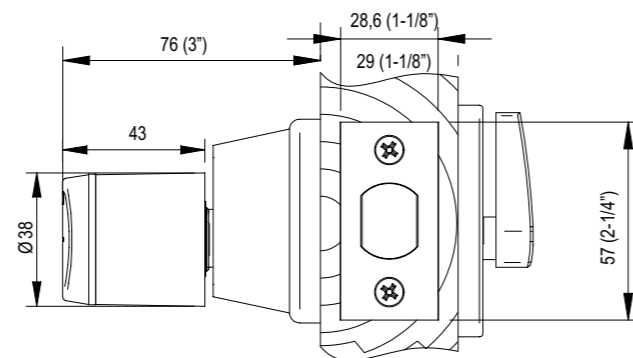

CERTIFICATIONS:

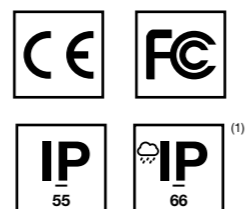

(1) Depending on the model
(*) NFC compatible smartphones only.

SALTO GEO - AUSTRALIA

SALTO GxA | AUSTRALIAN OVAL CYLINDER

The SALTO GEO Australian oval profile cylinder is specially designed to fit most Australian doors that are equipped with an Australian oval profile cylinder mortise lock.



FEATURES:

- SALTO SVN and SALTO Wireless network capable.
- All communication between the carrier and the electronic cylinder is encrypted and secured.
- The batteries can be replaced without cylinder removal.
- Optical signalling through light ring. Dual colour green/red to indicate access authorisation. Acoustic signal optional.
- Equipped with anti-drilling protection.
- Optional torx screw to tighten the knob and convert the cylinder on a fixed knob cylinder.
- Emergency opening via portable programming device (PPD).

READER COLOUR:



FINISHES:



CS CP PM PP NE BC

TECHNICAL CHARACTERISTICS:

- Single oval cylinder for Australian mortise locks.
- Australian standard 'X' cam.

TECHNOLOGY PLATFORMS:

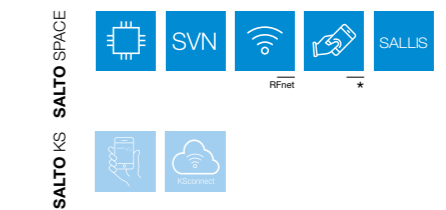

ID TECHNOLOGIES:

- MIFARE® (DESFire EV1, Plus, Ultralight C, Classic - ISO/IEC 14443).
- NFC.
- LEGIC Prime and LEGIC Advant.
- HID iCLASS®.
- i-Button.

TECHNICAL DRAWING:

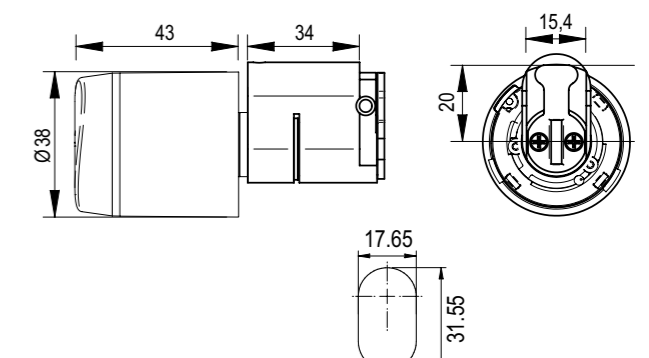

CERTIFICATIONS:

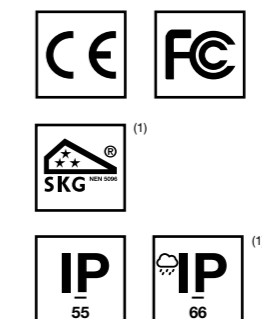

(1) Depending on the model
(*) NFC compatible smartphones only.

SALTO GEO - SWING HANDLE

SALTO GxE | SWING HANDLE

The SALTO GEO half cylinder is specially designed to fit most swing handle* rack servers. Ideal for use on applications where control of the operation of the rack is needed, enhancing the control and security of access to the server racks.



TECHNICAL CHARACTERISTICS:

- Available for distances from 40mm up to 45mm.
- Optional, with knob extension of 5mm or 10mm for swing handles with sliding cover.
- Special auto locking cam.
- Compatible with most market standard racks swing handle (Dirak®, Emka® and others).

TECHNOLOGY PLATFORMS:

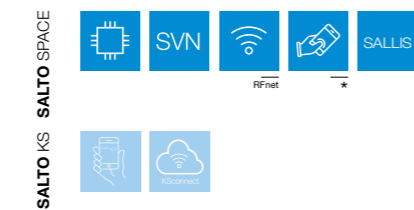

ID TECHNOLOGIES:

- MIFARE® (DESFire EV1, Plus, Ultralight C, Classic - ISO/IEC 14443).
- NFC.
- LEGIC Prime and LEGIC Advant.
- HID iCLASS®.
- i-Button.

FEATURES:

- SALTO SVN and SALTO Wireless network capable.
- All communication between the carrier and the electronic cylinder is encrypted and secured.
- The batteries can be replaced without cylinder removal.
- Optical signalling through light ring. Dual colour green/red to indicate access authorisation. Acoustic signal optional.
- Equipped with anti-drilling protection.
- Optional torx screw to tighten the knob and convert the cylinder on a fixed knob cylinder.
- Emergency opening via portable programming device (PPD).

READER COLOUR:



FINISHES:

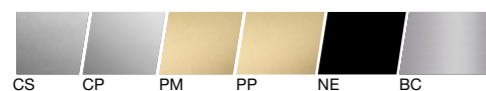

TECHNICAL DRAWING:

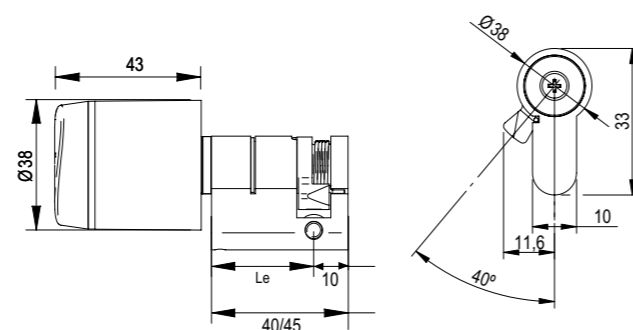

CERTIFICATIONS:

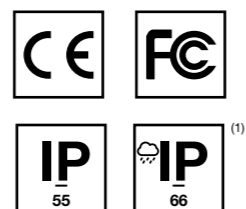

SALTO GEO - CAM LOCK

SALTO GxCL | CAM LOCK CYLINDER

The SALTO GEO Cam Lock electronic cylinder is specially designed to fit most cabinets equipped with a cam locking mechanism. The cam itself acts as a locking bolt and is directly operated when the card is presented by the user and turns the plug. The cam rotates between 180 and 90 degrees, securing the lock. This patented system provides an extra level of protection from intrusions with a high security blocking mechanism that is exclusive to SALTO.



TECHNICAL CHARACTERISTICS:

- Available from 1mm to 22mm door thickness.
- Easy installation on steel lockers or wooden doors.
- Different cam lengths: 28mm or 40mm included.
- 19mm body diameter.
- Security collar included for an accurate installation.

TECHNOLOGY PLATFORMS:

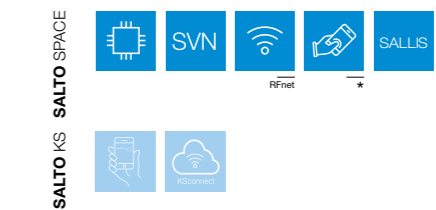

ID TECHNOLOGIES:

- MIFARE® (DESFire EV1, Plus, Ultralight C, Classic - ISO/IEC 14443).
- NFC.
- LEGIC Prime and LEGIC Advant.
- HID iCLASS®.
- i-Button.

FEATURES:

- SALTO SVN and SALTO Wireless network capable.
- All communication between the carrier and the electronic cylinder is encrypted and secured.
- The batteries can be replaced without cylinder removal.
- Optical signalling through light ring. Dual colour green/red to indicate access authorisation. Acoustic signal optional.
- Equipped with anti-drilling protection.
- Optional torx screw to tighten the knob and convert the cylinder on a fixed knob cylinder.
- Emergency opening via portable programming device (PPD).

READER COLOUR:



FINISHES:

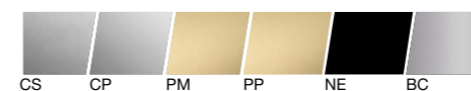

TECHNICAL DRAWING:

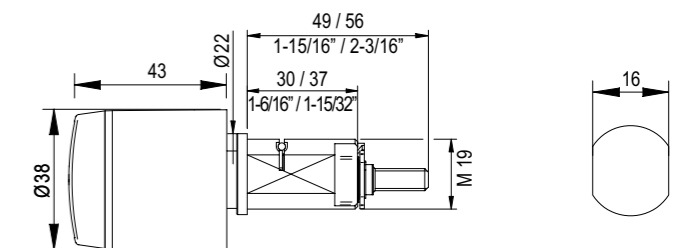

CERTIFICATIONS:

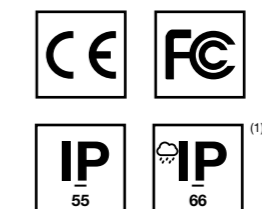

(1) Depending on the model
(*) NFC compatible smartphones only.

(1) Depending on the model
(*) NFC compatible smartphones only.

SALTO GEO - PADLOCKS

SALTO GxP | PADLOCKS

The SALTO GEO Electronic Padlock is a versatile locking solution that enables users to benefit from the advantages of electronic access control where previously it was only possible to use a mechanical locking solution (i.e., perimeter or fire access gates, industrial equipment yards and residential storage areas).



FEATURES:

- SALTO SVN and SALTO Wireless network capable.
- All communication between the carrier and the electronic cylinder is encrypted and secured.
- The batteries can be replaced without cylinder removal.
- Optical signalling through light ring. Dual colour green/red to indicate access authorisation. Acoustic signal optional.
- Equipped with anti-drilling protection.
- Optional torx screw to tighten the knob and convert the cylinder on a fixed knob cylinder.
- Suitable for medium to high security applications.
- Emergency opening via portable programming device (PPD).

READER COLOUR:



FINISHES:



CP

TECHNICAL CHARACTERISTICS:

- Polished chromium finish padlock.
- Shackle made of stainless steel.
- Different shackle lengths available: 30mm, 60mm or 90mm.
- Shackle diameter: 8mm (Only for 48mm body).
- Shackle diameter: 10mm (Only for 58mm body).
- Available only in polished chrome finish.

TECHNOLOGY PLATFORMS:

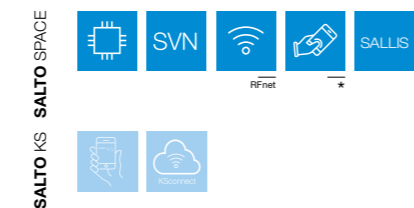

ID TECHNOLOGIES:

- MIFARE® (DESFire EV1, Plus, Ultralight C, Classic - ISO/IEC 14443).
- NFC.
- LEGIC Prime and LEGIC Advant.
- HID iCLASS®.
- i-Button.

TECHNICAL DRAWING:

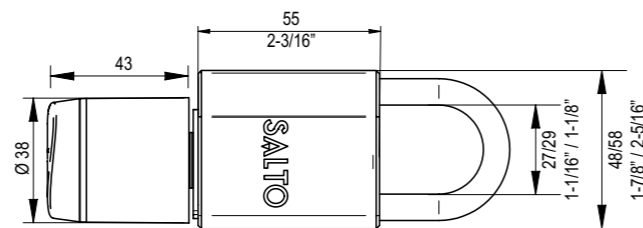

CERTIFICATIONS:

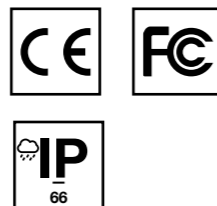

(*) NFC compatible smartphones only.

SALTO GEO - ACCESSORIES

SALTO GEO GRIPS | A (DDA) MODEL

SALTO GEO cylinder grips have been designed to improve the operation of SALTO GEO electronic cylinders by the disabled. The SALTO GEO electronic cylinder grips provide an additional surface, thereby making the knob easier to operate.



FINISHES:



FEATURES:

- DDA compliant, adapted to suit the disabled.
- Coated with BioCote® antimicrobial technology.

SALTO GEO GRIPS | H MODEL

SALTO GEO cylinder grips have been designed to improve the operation of SALTO GEO electronic cylinders. Suitable for use with gloves, the SALTO GEO electronic cylinder grips provide an additional surface, thereby making the knob easier to operate.



FINISHES:



FEATURES:

- Coated with BioCote® antimicrobial technology.

SALTO GEO | ELECTRONIC CYLINDER

REFERENCE GUIDE INFORMATION

The SALTO GEO range of electronic cylinders is fully integrated with the SALTO XS4 platform and their versatile, compact size makes them an ideal solution for almost any type of door where fitting a conventional electronic handle set is not possible or required.

G	9	E2	1	30	R	30	CSB	D	W	A	S	R
PRODUCT TYPE	ID TECHNOLOGY	MODEL	KNOB TYPE	EXTERIOR LENGTH	THUMBTURN	INTERIOR LENGTH	FINISHES	CAM	WIRELESS TECHNOLOGY	SPECIAL FUNCTION	CERTIFICATION	WATER RESISTANCE
1	2	3	4	5	6	7	8	9	10	11	12	13

1 | PRODUCT TYPE

G SALTO GEO electronic cylinder.

2 | ID TECHNOLOGY

i-Button

2 i-Button (Selfprogrammable, ROM and RW capable).

RFID

8 Contactless LEGIC® Advant & Prime.

9 Contactless MIFARE®.

H Contactless HID iCLASS®.

3 | MODEL

E1	Half Euro profile cylinder.	H2	Swiss round profile cylinder with thumbturn.
E2	Euro profile cylinder with thumbturn.	H3	Swiss round profile double cylinder, double knob.
E3	Euro profile double cylinder, double knob.	S1	Standard Scandinavian external cylinder.
U1	Half UK profile cylinder.	S2	Standard Scandinavian internal cylinder.
U2	UK profile cylinder with thumbturn.	S3	Scandinavian Security external cylinder.
U3	UK profile double cylinder, double knob.	M1	Mortise US profile cylinder.
K1	UK profile RIM cylinder.	B1-B2	US profile RIM cylinder.
H1	Half Swiss round profile cylinder.	B3	Heavy duty deadbolt.

3 | MODEL

A1	Australian oval profile cylinder.	CL	Cam lock cylinder.
E9	Electronic cylinder for swing handles.	P2	Cylinder Padlock.

4 | KNOB TYPE

- 1 Standard removable knob.
- 2 Removable knob with plug of 5mm.
- 3 Removable knob with plug of 10mm.

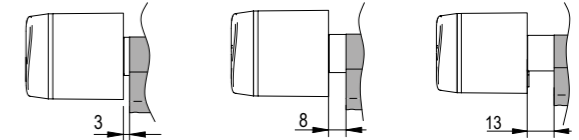

5 - 7 | EXTERIOR AND INTERIOR LENGTH

00	Not applicable.	60	60mm.	95	95mm.	1G	130mm.	1N	165mm.
30	30mm	65	65mm.	1A	100mm.	1H	135mm.	29	29mm.
35	35mm.	70	70mm.	1B	105mm.	1I	140mm.	32	32mm.
40	40mm.	75	75mm.	1C	110mm.	1J	145mm.	35	35mm.
45	45mm.	80	80mm.	1D	115mm.	1K	150mm.	38	38mm.
50	50mm.	85	85mm.	1E	120mm.	1L	155mm.	41	41mm.
55	55mm.	90	90mm.	1F	125mm.	1M	160mm.	44	50mm.

6 | THUMBTURN

- N No thumbturn.
- S Standard thumbturn.
- R Round thumbturn.

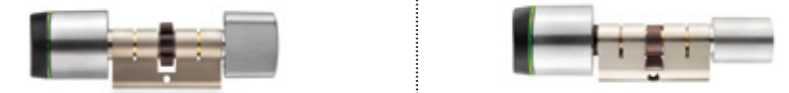

REFERENCE GUIDE INFORMATION

SALTO GEO | ELECTRONIC CYLINDER

The SALTO GEO range of electronic cylinders is fully integrated with the SALTO XS4 platform and their versatile, compact size makes them an ideal solution for almost any type of door where fitting a conventional electronic handle set is not possible or required.

8 | FINISHES

The SALTO GEO electronic cylinder is available in a choice of six different finishes (BioCote® Coating technology available), with proximity readers available in black or white, to perfectly complement any décor and design.

CSB: Satin chrome black reader
CSW: Satin chrome white reader



CPB: Polished chrome black reader
CPW: Polished chrome white reader



PPB: Polished bright brass type (PVD) black reader
PPW: Polished bright brass type (PVD) white reader



PMB: Satin brass type (PVD) black reader
PMW: Satin brass type (PVD) white reader



NEB: Satin black chromium black reader
NEW: Satin black chromium white reader



BCB: BioCote satin chrome black reader
BCW: BioCote satin chrome white reader



9 | CAM

N	Not applicable.	G	Cog wheel 10 tooth cam.
D	DIN 15mm.	Z	Cog wheel 13 tooth cam.
M	13,2 mm (Spain for metal doors).	A	Cam lock cam (standard "C" range).
K	UK 14,3 mm.	R	Swing handle cam.
H	Swiss 15mm.		

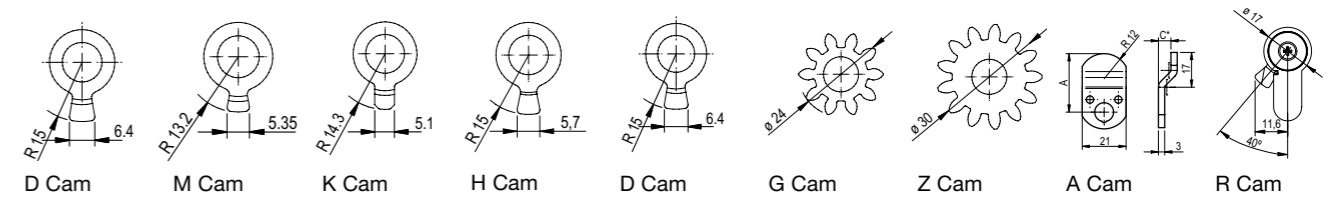

10 | WIRELESS TECHNOLOGY

-	Offline data-on-card capable.	S	SALLIS Wireless online technology.
W	Wireless online.	Y	SALTO KS by SALTO technology.

11 | SPECIAL FUNCTION

-	No panic function.
A	Panic function A.
K	AMOK function.

12 | CERTIFICATION

-	Standard certifications.
G	SKG*** certified.
V	VDS BZ+ certified.

13 | WATER RESISTANCE

-	Standard (IP55 - knob only).
R	Increased water resistance (IP66 - knob only).



Wall Readers

WALL READER

- European Wall Reader
- European Wall Reader with Keypad
- ANSI Wall Reader
- ANSI Wall Reader with Keypad
- Mullion Wall Reader
- Panel Wall Reader

MODULAR WALL READERS

- Modular Wall Reader
- Modular Wall Reader Pedestal
- Original Narrow Profile Wall Reader

EUROPEAN WALL READER ACCESSORIES

- Modular Keypad
- Modular Antivandalic Frame
- Modular Wall Reader Base

WALL READERS | PERIPHERALS

SALTO offers a wide range of wall readers that, in combination with SALTO Door Controllers enable the expansion of SALTO access control benefits to all those doors where a stand-alone electronic lock cannot be fitted, i.e. barriers, lifts, sliding doors or electronic gates, where control must be boosted by online real-time access control.

TECHNICAL DATA

- Modern aesthetic design with clear LED signaling.
- Fully integrated with the SALTO XS4 platform.
- Virtual network capable through SALTO Virtual Network data-on-card technology.
- Covering the mainstream RFID technologies.
- NFC compatible.
- All communications between the carrier and the wall reader are encrypted and secure.²
- Acoustic and optical signalling, dual colour green/red to indicate access authorisation.
- Blue coloured LED to indicate carrier updating.
- Available in different finishes.
- Concealed fixing screw for greater security and improved aesthetics.
- For external use and protection against vandalism; can be used with the WRMFWAV frame and flush mounting base.³
- Connection to the door controller using AWG24 twisted pair or AWG18 cable connection.
- Compatible with standard electrical back boxes for easy fitting.*
- Can be used for integration with other systems through the addition of the Wall Reader Adaptor or Control Unit Adaptor.
- Emergency opening by means of contactless portable programming device (PPD).

MAIN FEATURES

CURRENT REQUIRED:

- 5V supplied by the door controller.

CONNECTION WITH THE DOOR CONTROLLER:

- Using AWG24 twisted pair or AWG18 cable connection.

MAXIMUM DISTANCE BETWEEN THE DOOR CONTROLLER AND THE WALL READER:

- 400 meters⁴ using a twisted pair cable.

ENVIRONMENTAL CONDITIONS:

- External lock: -20° / 60°.

The wall readers read encrypted data contained on the carrier and communicate it to the door controller. They also allow for updating of the carrier via SALTO Virtual Network (SVN) technology, making it possible to cancel lost or stolen cards remotely.

ACCESS CONTROL FEATURES

USERS & DOORS:

- Maximum number of users per door: 4 million.
- Maximum number of doors per system: 65,000.
- Access levels: unlimited.

CALENDARS & TIME ZONES:

- Calendars in system: 256
- Timetables: 1024
- Time periods: 1024

EVENTS:

- Maximum events on controller: 5,000.
- Non volatile memory (memory is not deleted, even if power fails).

MANAGEMENT SOFTWARE:

- SALTO ProAccess SPACE.

ID TECHNOLOGIES:

- Covering the mainstream RFID contactless technologies.
- Compatible with ISO 14443A, ISO 14443B and ISO 15693 (Vicinity).

¹ Depending on the model

² Depending on the credential

³ For Modular Wall Reader range only

⁴ Depending on the cable

WALL READER

WRDB0E | EUROPEAN WALL READER

The SALTO Wall Reader incorporates the cutting-edge design standard of the XS4 2.0 product range in this technological powerhouse. In combination with the SALTO Controller, it facilitates the integration of the wall reader with almost any SALTO interface such as SALTO ProAccess SPACE, to provide your facility with a complete security solution.



FEATURES:

- Modern aesthetic design with green/red and blue clear LED colour optical signal.
- Conical or flat square shape with rounded corners.
- Compatible with standard European electric boxes.
- Virtual network capable through SALTO SVN data-on-card technology.
- Acoustic and optical signalling, dual colour green/red to indicate access authorisation.
- Blue light indicates that the user key update is in progress through SALTO Virtual Network technology.
- Available for surface mounting.
- Concealed fixing screws for greater security and improved aesthetics.
- Reader is housed in a two-piece, weatherproof secure electronics potted enclosure.

READER COLOUR:



TECHNICAL CHARACTERISTICS:

- Specially designed to fit European standard electric boxes, making the installation quick and easy.
- To be used in combination with controllers (CU42xxx) or SALTO KS controllers (CU41xxx).
- Connection to the door controller: 4 wires.
- Designed to work with an online SVN access control platform, or with a stand-alone system.
- Maximum distance between the door controller and the wall reader 400m¹ using a twisted pair cable.
- Includes tamper to monitor if the wall reader has been opened.
- Reading distance from 35 to 50mm depending on the RFID technology.

TECHNOLOGY PLATFORMS:



ID TECHNOLOGIES:

- MIFARE® (DESFire EV1, Plus, Ultralight C, Classic - ISO/IEC 14443).
- Bluetooth SMART (BLE).
- NFC.
- HID iCLASS® Seos™.

TECHNICAL DRAWING:

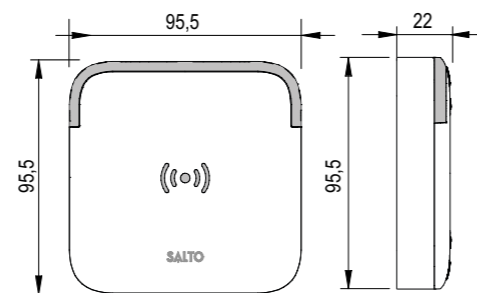

CERTIFICATIONS:

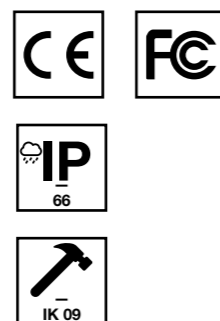

¹ Depending on the cable

WALL READER - KEYPAD

WRDBE_K | EUROPEAN WR WITH KEYPAD

The SALTO Wall Reader with keypad incorporates the cutting-edge design standard of the XS4 2.0 product range in this technological powerhouse. This product allows for the additional use of a Personal Identification Number (PIN) keypad option, increasing the security by using a double authentication and more enhanced opening modes.



FEATURES:

- Modern aesthetic design with green/red and blue clear LED colour optical signal.
- Conical or flat square shape with rounded corners.
- Compatible with standard European electric boxes.
- Virtual network capable through SALTO SVN data-on-card technology.
- Permits additional opening modes and user authentication through a user PIN.
- Keys are illuminated for better visibility (intelligent lighting).
- Acoustic and optical signalling, dual colour green/red to indicate access authorisation.
- Blue light indicates that the user key update is in progress through SALTO Virtual Network technology.
- Available for surface mounting.
- Concealed fixing screws for greater security and improved aesthetics.
- Reader is housed in a two-piece, weatherproof secure electronics potted enclosure.

OPENING MODES:

- Opening through key card.
- Opening through key card plus personal PIN.
- Opening through door code.

READER COLOUR:



TECHNICAL CHARACTERISTICS:

- Specially designed to fit European standard electric boxes, making the installation quick and easy.
- To be used in combination with controllers (CU42xxx)
- Connection to the door controller: 4 wires.
- Designed to work with an online SVN access control platform, or with a stand-alone system.
- Maximum distance between the door controller and the wall reader 400m¹ using a twisted pair cable.
- Includes tamper to monitor if the wall reader has been opened.
- Reading distance from 35 to 50mm depending on the RFID technology.

TECHNOLOGY PLATFORMS:



ID TECHNOLOGIES:

- MIFARE® (DESFire EV1, Plus, Ultralight C, Classic - ISO/IEC 14443).
- Bluetooth SMART (BLE).
- NFC.
- LEGIC® Advant & Prime.
- HID iCLASS® Seos™.

TECHNICAL DRAWING:

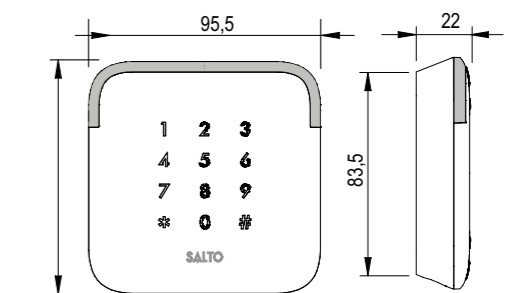

CERTIFICATIONS:

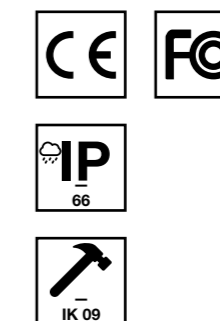

¹ Depending on the cable

WALL READER ANSI

WRDB0A | ANSI WALL READER

The SALTO Wall Reader incorporates the cutting-edge design standard of the XS4 2.0 product range in this technological powerhouse. The SALTO Wall Reader in combination with the SALTO Controller facilitates the integration of the wall reader with almost any SALTO interface, such as SALTO ProAccess SPACE to provide your facility with a complete security solution.

This wall reader has been specially designed to fit ANSI standard electric boxes to make the installation easier.



FEATURES:

- Modern aesthetic design with green/red and blue clear LED colour optical signal.
- Rectangular shape with rounded corners.
- Compatible with standard ANSI electric boxes.
- Virtual network capable through SALTO SVN data-on-card technology.
- Acoustic and optical signalling, dual colour green/red to indicate access authorisation.
- Blue light indicates that the user key update is in progress through SALTO Virtual Network technology.
- Available for surface mounting.
- Concealed fixing screws for greater security and improved aesthetics.
- Reader is housed in a two-piece, weatherproof secure electronics potted enclosure.

READER COLOUR:



TECHNICAL CHARACTERISTICS:

- To be used in combination with controllers (CU42xxx) or SALTO KS controllers (CU41xxx).
- Connection to the door controller: 4 wires.
- Designed to work with an online SVN access control platform, or with a stand-alone system.
- Maximum distance between the door controller and the wall reader 400m¹ using a twisted pair cable.
- Includes tamper to monitor if the wall reader has been opened.
- Reading distance from 35 to 50mm depending on the RFID technology.

TECHNOLOGY PLATFORMS:



ID TECHNOLOGIES:

- MIFARE® (DESFire EV1, Plus, Ultralight C, Classic - ISO/IEC 14443).
- Bluetooth SMART (BLE).
- NFC.
- HID iCLASS® Seos™.

TECHNICAL DRAWING:

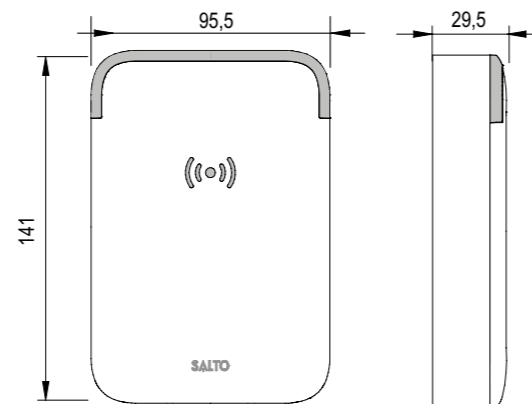

CERTIFICATIONS:

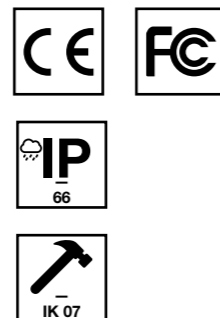

¹ Depending on the cable

WALL READER ANSI - KEYPAD

WRDB0A_K | ANSI WR WITH KEYPAD

The SALTO Wall Reader with keypad incorporates the cutting-edge design standard of the XS4 2.0 product range in this technological powerhouse. This product allows for the additional use of a Personal Identification Number (PIN) keypad option, increasing the security by using a double authentication and more enhanced opening modes.

This wall reader has been specially designed to fit ANSI standard electric boxes to make the installation easier.



FEATURES:

- Modern aesthetic design with green/red and blue clear LED colour optical signal.
- Rectangular shape with rounded corners.
- Compatible with standard ANSI electric boxes.
- Virtual network capable through SALTO SVN data-on-card technology.
- Permits additional opening modes and user authentication through a user PIN.
- Keys are illuminated for better visibility (intelligent lighting).
- Acoustic and optical signalling, dual colour green/red to indicate access authorisation.
- Blue light indicates that the user key update is in progress through SALTO Virtual Network technology.
- Available for surface mounting.
- Concealed fixing screws for greater security and improved aesthetics.
- Reader is housed in a two-piece, weatherproof secure electronics potted enclosure.

OPENING MODES:

- Opening through key card.
- Opening through key card plus personal PIN.
- Opening through door code.

READER COLOUR:



TECHNICAL CHARACTERISTICS:

- To be used in combination with controllers (CU42xxx)
- Connection to the door controller: 4 wires.
- Designed to work with an online SVN access control platform, or with a stand-alone system.
- Maximum distance between the door controller and the wall reader 400m¹ using a twisted pair cable.
- Includes tamper to monitor if the wall reader has been opened.
- Reading distance from 35 to 50mm depending on the RFID technology.

TECHNOLOGY PLATFORMS:



ID TECHNOLOGIES:

- MIFARE® (DESFire EV1, Plus, Ultralight C, Classic - ISO/IEC 14443).
- Bluetooth SMART (BLE).
- NFC.
- LEGIC® Advant & Prime.
- HID iCLASS® Seos™.

TECHNICAL DRAWING:

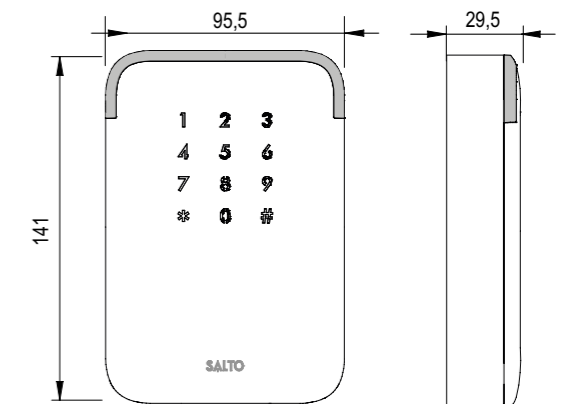

CERTIFICATIONS:



¹ Depending on the cable



WALL READER - MULLION

WRDB0M | MULLION READER

The SALTO slim wall reader for flush mounting has been specially designed to fit lifts, sliding doors or electronic gate doors that have a narrow profile frame, and where there is insufficient space to install a standard wall reader.



FEATURES:

- Compact slim reader module design reader.
- Specially designed for narrow or aluminium profile doors, making the installation quick and easy with minimal impact.
- Fully integrated with the SALTO XS4 platform.
- Virtual network capable through SALTO SVN data-on-card technology.
- Modern aesthetic design with green/red and blue clear LED colour optical signal.
- Blue light indicates that the user key update is in progress through SALTO Virtual Network technology.
- Acoustic and optical signalling, dual colour green/red to indicate access authorisation.
- Reader is housed in a two-piece, weatherproof secure electronics potted enclosure.

READER COLOUR:



TECHNICAL CHARACTERISTICS:

- To be used in combination with controllers (CU42xxx or SALTO KS controllers (CU41xxx).
- Connection to the door controller: 4 wires.
- Designed to work with an online SVN access control platform, with a stand-alone system or cloud-based SALTO KS access control platform.
- Maximum distance between the door controller and the wall reader 400m¹ using a twisted pair cable.
- Reading distance from 35 to 50mm depending on the RFID technology.

TECHNOLOGY PLATFORMS:



ID TECHNOLOGIES:

- MIFARE® (DESFire EV1, Plus, Ultralight C, Classic - ISO/IEC 14443).
- Bluetooth SMART (BLE).
- NFC.
- HID iCLASS® Seos™.

TECHNICAL DRAWING:

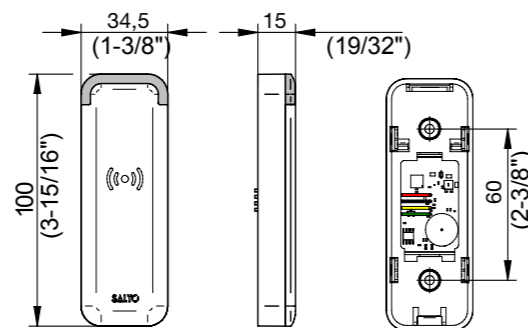

CERTIFICATIONS:

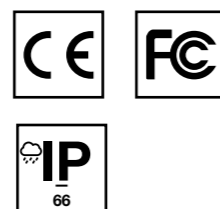

¹ Depending on the cable



WALL READER - PANEL READER

WRD_P | PANEL READER

The SALTO panel reader is a door entry system that works in conjunction with SALTO controllers. Designed to be integrated behind lift panels, door intercoms, electric switches or turnstiles & gates. These models need a window, which is necessary for reader antenna operation.



TECHNICAL CHARACTERISTICS:

- To be used in combination with controllers (CU42xxx) or SALTO KS controllers (CU41xxx).
- Connection to the door controller: 4 wires.
- Designed to work with an online SVN access control platform, with a stand-alone system or cloud-based SALTO KS access control platform.
- Maximum distance between the door controller and the wall reader 400m¹ using a twisted pair cable.
- Reading distance from 35 to 50mm depending on the RFID technology.

TECHNOLOGY PLATFORMS:



ID TECHNOLOGIES:

- MIFARE® (DESFire EV1, Plus, Ultralight C, Classic - ISO/IEC 14443).
- Bluetooth SMART (BLE).
- NFC.
- HID iCLASS® Seos™.

FEATURES:

- Compact reader module reader.
- Specially designed to be integrated behind lifts panels, door intercoms, electric switches...
- Fully integrated with the SALTO XS4 platform.
- Virtual network capable through SALTO SVN data-on-card technology.
- Acoustic and optical signalling, dual colour green/red to indicate access authorisation.
- Reader is housed in one piece, weatherproof secure electronics potted enclosure.
- Two stickers & labels are available for visible signage.

TECHNICAL DRAWING:

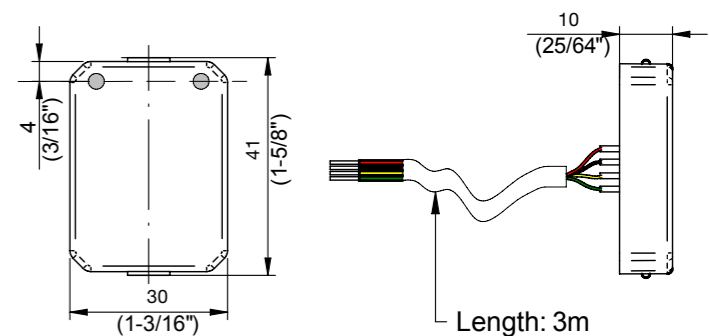

CERTIFICATIONS:



¹ Depending on the cable

WALL READER - MODULAR 2.0

XS4 WRMB0E | MODULAR WALL READER 2.0

The SALTO Modular Wall Reader 2.0, in combination with the SALTO Controller, facilitates the integration of the wall reader with almost any SALTO interface, such as SALTO ProAccess SPACE to provide your facility with a complete security solution for any kind of installations, even from adverse and harsh environments thanks to the ability to install it in combination with the antivandalic frame.



FEATURES:

- Square reader design with green/red and blue LED signal.
- Compatible with standard European electric boxes using the standard bases.
- Virtual network capable through SALTO Virtual Network technology.
- Acoustic and optical signalling, dual colour green/red to indicate access authorisation.
- Blue light indicates that the user key update is in progress through SALTO Virtual Network technology.
- For flush or surface mounting depending on the base (base sold separately).
- Concealed fixing screw for greater security and improved aesthetics.
- Reader is housed in a two-piece, weatherproof secure electronics potted enclosure.

READER COLOUR:



TECHNICAL CHARACTERISTICS:

- To be used in combination with SALTO controllers.
- Connection to the door controller: 4 wires.
- Designed to work with an online SVN access control platform, or with a stand-alone system.
- Maximum distance between the door controller and the wall reader 400m¹ using a twisted pair cable.
- Includes tamper to monitor if the wall reader has been opened.
- Reading distance from 35 to 50mm depending on the RFID technology.

TECHNOLOGY PLATFORMS:



ID TECHNOLOGIES:

- MIFARE® (DESFire EV1, Plus, Ultralight C, Classic - ISO/IEC 14443).
- Bluetooth SMART (BLE).
- NFC.
- HID iCLASS® Seos™.

TECHNICAL DRAWING:

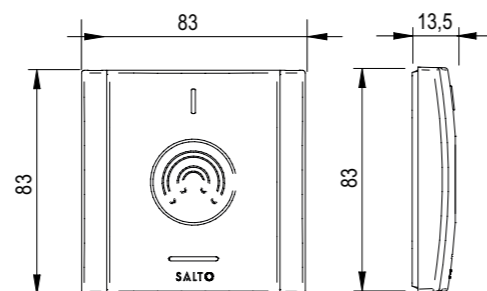

CERTIFICATIONS:



¹ Depending on the cable

WALL READER - MODULAR

XS4 WRMX | MODULAR WALL READER

The Original Modular wall reader offers a broad range of 13,56Mhz RFID cards of the mainstream contactless smart key card application technologies on the market. It reads encrypted data from the carriers and then communicates it to the door controllers.



FEATURES:

- Square reader design with green/red and blue LED signal.
- Compatible with standard European electric boxes using the standard bases.
- Fully integrated with the SALTO XS4 platform.
- Virtual network capable through SALTO Virtual Network technology.
- Acoustic and optical signalling, dual colour green/red to indicate access authorisation.
- Available in silver finish.
- For flush or surface mounting depending on the base (base sold separately).
- Concealed fixing screw for greater security and improved aesthetics.
- Optional keypad features in combination with WRMKP.
- For an enhanced robustness it can be combined with the antivandalic frame WRMFWAV.
- Reader is housed in a two-piece, weatherproof secure electronics potted enclosure.

READER COLOUR:



TECHNICAL CHARACTERISTICS:

- To be used in combination with controllers (CU50xx).
- Connection to the door controller: 5 wires.
- Designed to work with an online SVN access control platform, or with a stand-alone system.
- Maximum distance between the door controller and the wall reader 100m¹ using a twisted pair cable.
- Reading distance from 35 to 50mm depending on the RFID technology.

TECHNOLOGY PLATFORMS:

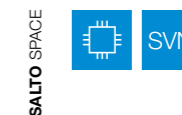

ID TECHNOLOGIES:

- MIFARE® (DESFire EV1, Plus, Ultralight C, Classic - ISO/IEC 14443).
- NFC.
- Inside Picopass.
- LEGIC Prime and LEGIC Advant.
- HID iCLASS®.
- i-Button.

TECHNICAL DRAWING:

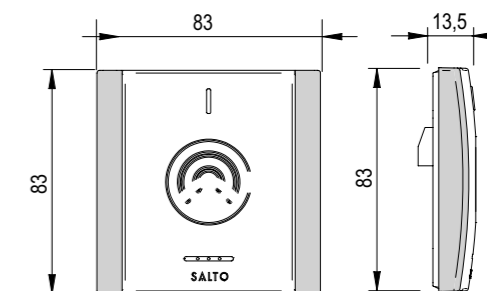

CERTIFICATIONS:



¹ Depending on the cable
² Depending on the model
* RFID models

WALL READER - ORIGINAL

WRXXFS | ORIGINAL WALL READER NARROW

The SALTO Original slim wall reader for flush mounting has been specially designed to fit lifts, sliding doors or electronic gate doors that have a narrow profile frame, and where there is insufficient space to install a standard wall reader.

It offers a broad range of 13,56Mhz RFID contactless smart cards for mainstream RFID technologies. All communication between the carrier and the wall reader is encrypted and secured to communicate to the CU5000 door controller range. They also allow for updating of the carriers via SALTO Virtual Network data-on-card technology.



FEATURES:

- Compact slim reader module design reader with green/red LED signal.
- Easy to install, designed for surface mounting in both indoor and outdoor non-protected environment use.
- Fully integrated with the SALTO XS4 platform.
- Virtual network capable through SALTO Virtual Network technology.
- Acoustic and optical signalling, dual colour green/red to indicate access authorisation.

READER COLOUR:



TECHNICAL CHARACTERISTICS:

- To be used in combination with SALTO controllers (CU50xx).
- Designed to work with an online SVN access control platform, or with a stand-alone system.
- Connection to the door controller: 5 wires.
- Maximum distance between the door controller and the wall reader 100m¹ using a twisted pair cable.
- Reading distance from 35 to 50mm depending on the RFID technology.

TECHNOLOGY PLATFORMS:



ID TECHNOLOGIES:

- MIFARE® (DESFire EV1, Plus, Ultralight C, Classic - ISO/IEC 14443).
- NFC.
- Inside Picopass.
- LEGIC Prime and LEGIC Advant.
- HID iCLASS®.
- i-Button.

TECHNICAL DRAWING:

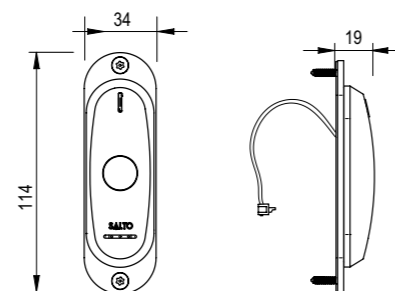

CERTIFICATIONS:

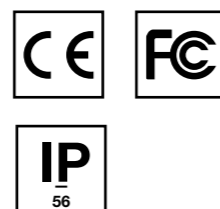

¹ Depending on the cable

WALL READER - PEDESTAL

WRMPX | WALL READER PEDESTAL

A parking or gate pedestal designed for the SALTO Modular Wall Reader range is a product developed to allow for the installation of readers and controllers in places where they cannot normally be fitted, such as on door frames, automatic barriers or electrical gates. Suitable for indoor and outdoor use; it can be combined with any model XS4 Original wall reader and 5000 door controller series.

Made of AISI316L bright polished stainless steel and DDA compliant, the Modular Wall Reader Pedestal is suitable for use in a wide range of environments including hospitals, airports, universities, schools, etc.



FEATURES:

- Aesthetically pleasing, architecturally designed, functional, high quality, strong and durable.
- DDA compliance optional.
- Fully integrated with the SALTO XS4 platform and SALTO Virtual Network capable in combination with XS4 door controller.
- Acoustic and optical signalling, dual colour green/red to indicate access authorisation.
- Optional with keypad features in combination with WRMKP.
- Can be combined with the antivandalic frame WRMFVAV for enhanced robustness.
- Special base cut out for easier installation and pedestal door panel for easy maintenance (base plate, side walls, reader panel).
- Single height reader pedestal suits general access control requirements and is suitable for many different applications.
- Concealed fixing screw for greater security and improved aesthetics.

PEDESTAL FINISH:



TECHNICAL CHARACTERISTICS:

- Made of AISI 316L bright polished stainless steel.
- To be used in combination with SALTO controllers (CU50xx).
- Connection to the door controller: 5 wires.
- Designed to work with an online SVN access control platform, or with a stand-alone system.
- Maximum distance between the door controller and the wall reader 100m¹ using a twisted pair cable.
- Reading distance from 35 to 50mm depending on the RFID technology.

TECHNOLOGY PLATFORMS:



ID TECHNOLOGIES:

- MIFARE® (DESFire EV1, Plus, Ultralight C, Classic - ISO/IEC 14443).
- NFC.
- Inside Picopass.
- LEGIC Prime and LEGIC Advant.
- HID iCLASS®.
- i-Button.

TECHNICAL DRAWING:

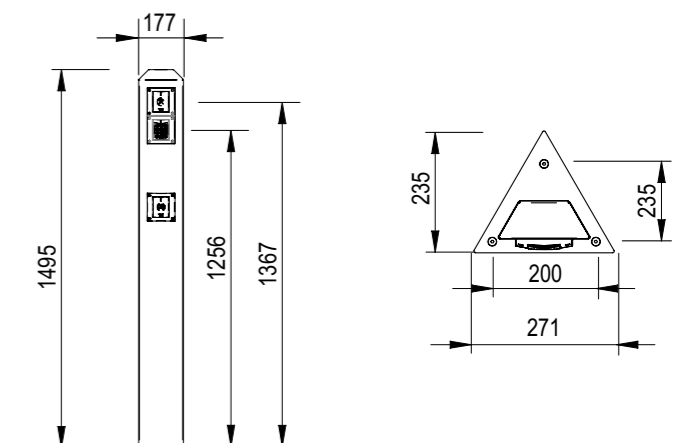

CERTIFICATIONS:



¹ Depending on the cable

WALL READER - ACCESSORIES

WRMFH | ANTIVANDALIC FRAME

This accessory has been designed to protect the WRM wall reader from adverse and harsh environments.



FEATURES:

- Robust, aesthetic design.
- Fastened with torx 10 anti tamper screws.
- Includes a special mounting base with a rubber gasket for outdoor use.
- Available in satin chrome finish.
- For surface mounting WRMFHAV.
- For flush mounting WRMFWAV.

TECHNICAL CHARACTERISTICS:

- Made of die cast zinc alloy with satin chrome finishing.
- To be used in combination with XS4 Original Modular wall reader (WRMxxx) and Modular wall reader XS4 2.0 (WRMBxxx).

TECHNICAL DRAWING:

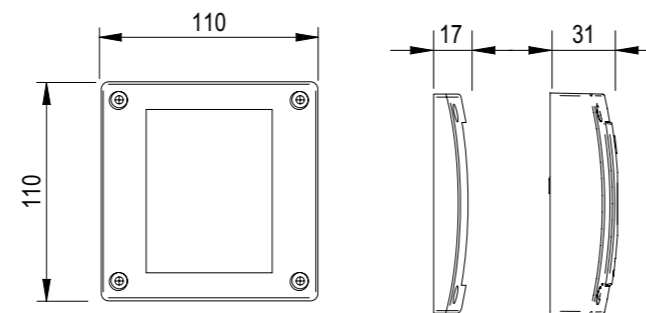

WALL READER - ACCESSORIES

WRMB | MODULAR WALL READER BASES

SALTO offers several base options to fit modular wall readers. Depending on your needs, you can choose a single or double base to fit a wall reader and a keypad.

Both bases include an internal gasket to prevent water ingress and have several fixing points to allow for adjustment during installation.

MODELS:

- Single and double bases for flush mounting



WRMBL1

WRMBL2

- Single and double bases for surface mounting



WRMBH1

WRMBH2

FEATURES:

- Compatible with standard European electric boxes using the standard bases.
- Available in different finishes depending on the WRM.
- For surface mounting WRMFHAV.
- For flush mounting WRMFWAV.

BASE COLOUR:



WRMKP | KEYPAD MODULAR WALL READER

Compatible with SALTO modular wall readers, the WRMKP keypad allows for the additional use of a Personal Identification Number (PIN) key pad option. It should be mounted on one of the SALTO WRM double mount bases.



FEATURES:

- PIN code authentication needed with ID carrier to gain access and obtain card update.
- Door code only option for non-key holders.
- PIN needed for SVN key update.
- Timed PIN option for ID carriers only operation and ID carrier plus PIN use.

TECHNICAL CHARACTERISTICS:

- To be used in combination with XS4 Original Modular wall readers (WRMxxx).
- Body made of die cast zinc alloy with satin chrome finish.
- Keys made of AISI 316L stainless steel.
- Connection to the wall reader with a built in cable.
- Current required 5V supplied by the Modular Wall Reader.

TECHNICAL DRAWING:

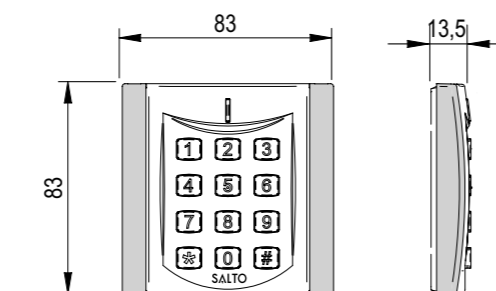



Vehicle Access

LONG DISTANCE READER

LDR2 / LDR1

Converter

VEHICLE ACCESS | LONG DISTANCE READER

The fast and reliable long range identification solution automatically identifies user's flow in any weather conditions without having to present the card on the reader. The product is suitable for car parks, traffic management, free flowing vehicle access control and convenience in general as the

carrier is read at a certain distance (refer to the model specifications for more information). The LDR is fully integrated into the SALTO ProAccess SPACE system through the XS4 online controller.

TECHNICAL DATA

CURRENT REQUIRED:

- 12...28 +20 % VDC / max. 1 A

FREQUENCIES:

- MHz 865 – 868 (EU)
- MHz 902 – 928 (US)
- MHz 916 – 921 (JP 4W E.I.R.P.)
- MHz 916 – 924 (JP 0.5W E.I.R.P.)

TRANSPONDER PROTOCOLS:

ISO18000-6 C (EPC Class1 Gen2)

ENVIRONMENTAL CONDITIONS:

- External lock: -20° / 60°.
- IP65 suitable for outside use.

ANTENNAS WITH BEAM WIDTH/POLARIZATION:

- 90° circular
- Transmit Power: E.R.P. max. 1 W (configurable)

CONNECTION WITH THE DOOR CONTROLLER:

- 4 pin connector using AWG24 twisted pair or AWG18 cable connection.

MAXIMUM DISTANCE BETWEEN THE DOOR CONTROLLER AND THE WALL READER:

- Between 5m and 100m depending on the cable and the voltage.

MAIN FEATURES

- 2 reader models:
 - Reading distance up to 7m.
 - Reading distance up to 3m.
- UHF passive technology.
- Dual cards available:
 - UHF+DESFire 8k
 - UHF+Mifare 4k
- 8 bytes printed code.
- UHF Windshield stickers.
- UHF On metal stickers.
- Wiegand connection to the CU42E0 (online version only).
- Unique user is managed in ProAccess SPACE (RFID/UHF)
- Suitable for vehicle access.
- Suitable for outdoor use (IP65).
- 12VDC-24VDC (power supply not included).

ACCESS CONTROL FEATURES

USERS & DOORS:

- Maximum number of users per door: 4 million.
- Maximum number of doors per system: 65,000.
- Access levels: unlimited.

MANAGEMENT SOFTWARE:

- SALTO ProAccess SPACE.

ID TECHNOLOGIES:

- SALTO UHF 8 bytes credential.

LONG-DISTANCE READER

WRLUD24BXX - WRLUD14BXX | [VEHICLE ACCESS](#)

Extremely robust die-cast aluminium housing and compact design with integrated antenna. The WRLUD24Bxx boasts a range of 7m and the WRLUD14Bxx covers 3m. It is a complementary product to the SALTO XS4 online Controller for real-time identification on the go.



FEATURES:

- Modern aesthetic and robust design with 3 LEDs green/red and blue.
- Can be mounted on pipes or surface mounted.
- Compatible with SALTO XS4 Controller online version (CU42E0 only).
- Reading distance between 1 and 7 meters depending on the model.

MODELS:



Range of 3 m
WRLUD14Bxx

Range of 7 m
WRLUD24Bxx

TECHNICAL CHARACTERISTICS:

- Dimensions: 200mm x 175mm x 60mm (W x H x D)
- Weight: kg 1.2 kg.
- Housing Material: ABS/PC, Al (powder-coated)
- Transmit Power: E.R.P. max. 1 W (configurable)
- Transponder Protocols: ISO18000-6 C (EPC Class1 Gen2)
- Interface: RS485 (deBus Protocol)
- Electrical Connection: M12-Connector with 4 Pins

TECHNOLOGY PLATFORMS:



ID TECHNOLOGIES:

- SALTO UHF 8 bytes credential.

TECHNICAL DRAWING:

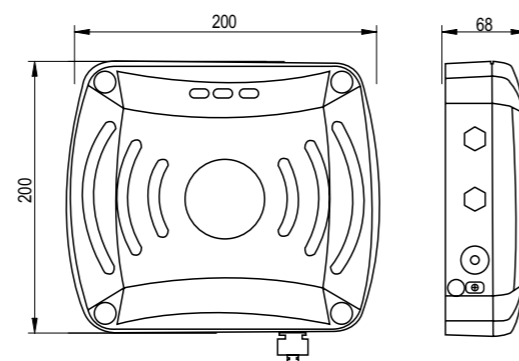

CERTIFICATIONS:



- UL 294 (pending)

CONVERTER

WRLUD-SIC1 | [VEHICLE ACCESS](#)

The WRLUD-SIC1 Wiegand converter is the link between the WRLUD and the CU42E0. It manages the real time communications assuring a perfect connection to the SALTO ProAccess SPACE software.

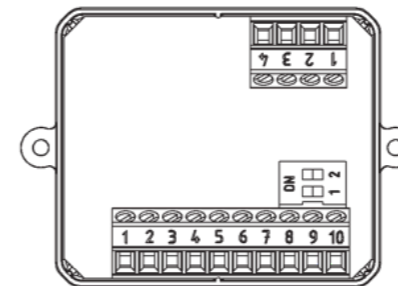
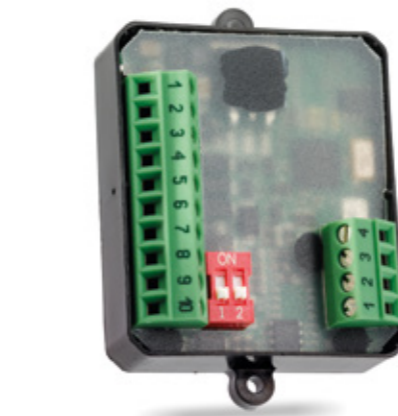

TECHNICAL CHARACTERISTICS:

- Dimensions: 59mm x 41,5mm x 14mm (W x H x D)
- Material: ASA
- Operating temperature: -20 ... 60 (-4 ... 140), non-condensing
- Voltage supply: 12 ... 24 V/DC, 40mA
- Electrical protection: Transient and reverse polarity protection
- Interface: Wiegand

TECHNICAL DRAWING:

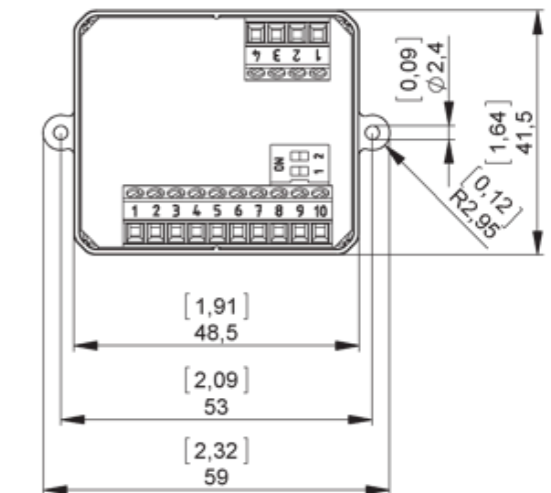



Control Units (CUs)

CONTROL UNITS

- CU SVN Online
- CU Auxiliary
- Expansion Board

MODULAR CONTROL UNITS

- Modular CU SVN Online
- Modular CU Stand-Alone
- Modular Extension Board
- Modular Integration Boards

CONTROL UNITS | CONTROLLERS

SALTO offers a wide range of door controllers that enable the expansion of SALTO access control benefits to all those doors where a stand-alone electronic escutcheon cannot be fitted.

TECHNICAL DATA

CURRENT REQUIRED:

- 12V / 500mA adaptor included.

NETWORK CONNECTION

- IP door controller Ethernet.

ENVIRONMENTAL CONDITIONS:

- -20°C to 80°C.¹

RELAY OUTPUT:

- Maximum current of the contact to relay 16A at 250VAC with resistive loads and 8A at 250VAC with inductive loads.¹

MAIN FEATURES

- Offline or online door controllers depending on the model.
- Virtual Network capable through SALTO Virtual Network technology.
- User on card audit trailing capability via the SALTO Virtual Network (SVN).
- All communications between the wall reader and the door controller and between the door controller and the PC are secured and encrypted for a higher security level.
- No additional control panels are required.
- Alarm input.¹
- Compatible with SALTO relay extension board, controlling up to 128 relay outputs suitable for elevators, etc.
- Possible to connect 3rd party readers to SALTO access control platform by Wiegand interface.
- Set up done with Portable Programming Device (PPD) or directly from the PC.*
- Update made with Portable Programming Device (PPD) or SVN.
- Antipassback mode available depending on the model.
- Firmware upgrade by means of PPD or directly from the PC on the online units.
- User on card audit trailing via SALTO Virtual Network in the case of offline units.

The door controllers read encrypted data contained on the carrier and allow for updating of the carrier via SALTO Virtual Network technology, making it possible to cancel lost or stolen cards remotely.

ACCESS CONTROL FEATURES

USERS & DOORS:

- Maximum number of users per door: 4 million.
- Maximum number of doors per system: 65,000.
- Access levels: unlimited.

CALENDARS & TIME ZONES:

- Calendars in system: 256
- Timetables: 1024
- Time periods: 1024

EVENTS:

- Maximum events on lock audit: 5,000.
- Non volatile memory (memory is not deleted, even if power fails).

MANAGEMENT SOFTWARE:

- SALTO ProAccess SPACE.

LOCK MODES

STANDARD:

Locked at all times.

OFFICE MODE:

Free passage.

TIMED OFFICE:

Automatic locking at end time.

AUTOMATIC OPENING:

8 pairs of "hands free" timed lock and unlocks per day with holidays.

TOGGLE:

Present card to lock, present card to unlock.

TIMED TOGGLE:

Present card to lock, present card to unlock depending on schedules

¹ Depending on the model

CU SVN ONLINE - CONTROLLER

CU42E0 | ETHERNET CONNECTED CU

SALTO's control unit makes it even easier to bring superior access control to your facility, thanks to the ability to control and manage multiple doors through one Ethernet connection and one IP address.

This means that extending SALTO access control benefits to all those doors where a stand-alone electronic escutcheon cannot be fitted (electric strikes, magnets, barriers, lifts, etc.) is even easier and more cost-effective.



FEATURES:

- Online TCP/IP networked based door control unit.
- Virtual network capable through SALTO Virtual Network data-on-card technology.
- Two wall reader connections that can be configured as 2 different doors or one door reader in and reader out locking.
- Can control up to 4 auxiliary XS4 controllers and manage up to 10 doors.
- Antipassback mode.
- Door monitoring and tamper monitoring via contacts input (intrusion alarm and door left opened alarm.)
- Compatible with SALTO relay expansion board, (CU4EB8) controlling up to 128 relay outputs.
- Compatible with the SALTO ProAccess SPACE alarm engine event module to manage trigger events through inputs or audit events.

FINISHES:



Translucent housing
CU42E0T

Grey housing
CU42E0G

TECHNICAL CHARACTERISTICS:

- Connection to the network through Ethernet connection 100BASE-T.
- 4 relay outputs.
- 6 inputs to connect to:
 - Door detector, request to exit switch (RTE), office switch, roller blind control, intrusion inhibition.
- 2 tamper inputs (input, switch).
- The maximum cable length between the door controller and the wall reader is up to 400 meters.¹
- Connection to the wall reader using 4 wire connection, twisted pair.
- Power consumption: 12V DC 400mA (without XS4 2.0 readers), supplied by an adaptor.

TECHNOLOGY PLATFORMS:



ID TECHNOLOGIES:

- To be used with WRDB and WRMB wall reader range.
- MIFARE® (DESFire EV1, Plus, Ultralight C, Classic - ISO/IEC 14443).
- Bluetooth SMART (BLE).
- NFC.
- HID iCLASS®.

TECHNICAL DRAWING:

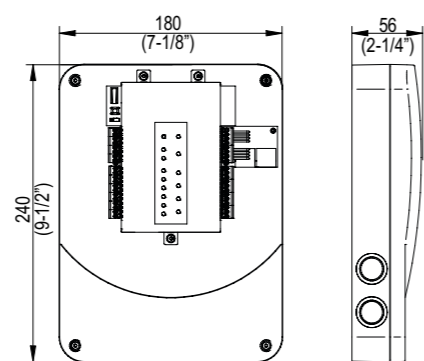

CERTIFICATIONS:



¹ Depending on the cable

CU AUXILIARY - CONTROLLER

CU4200 | AUXILIARY CONTROL UNIT

SALTO's latest control unit makes it even easier to bring superior access control to your facility, thanks to the ability to control and manage multiple doors through one Ethernet connection and one IP address.

The new SALTO Controller CU4200 is an auxiliary controller that does not require an IP address and can be set up as an auxiliary controller connected to an XS4 online controller (CU42E0), or can work as an offline controller, reducing the costs of installation and keeping all the advantages of the SALTO data-on-card technology.



FEATURES:

- Online controller if connected through BUS485 to CU42E0.
- Offline controller if not connected to the network.
- Two wall reader connections that can be configured as 2 different doors if it is connected to CU42E0, or one door reader in and reader out locking, if set up as offline and programmed via PPD.
- Antipassback mode available by connecting 2 wall readers and setting up as one door.
- Door monitoring and tamper monitoring via contacts input (intrusion alarm and door left opened alarm.)
- Access plan update via SALTO Virtual Network capabilities. User access plan and blacklist (list of user cards cancelled) is transmitted via the data-on-card technology.

FINISHES:



Translucent housing
CU4200T

Grey housing
CU4200G

¹ Depending on the cable

TECHNICAL CHARACTERISTICS:

- Connection to the Ethernet controller through BUS485.
- 4 relay outputs.
- 6 inputs to connect to:
 - Door detector, request to exit switch (RTE), office switch.
- 2 different tampers:
 - One tamper input.
 - One tamper switch.
- The maximum cable length between the door controller and the wall reader is up to 400 meters.¹
- Connection to the wall reader using 4 wire connection, twisted pair.
- Power consumption: 12V DC 400mA (without XS4 2.0 readers), supplied by an adaptor.

TECHNOLOGY PLATFORMS:



ID TECHNOLOGIES:

- To be used with WRDB and WRMB wall reader range.
- MIFARE® (DESFire EV1, Plus, Ultralight C, Classic - ISO/IEC 14443).
- Bluetooth SMART (BLE).
- NFC.
- HID iCLASS®.

TECHNICAL DRAWING:

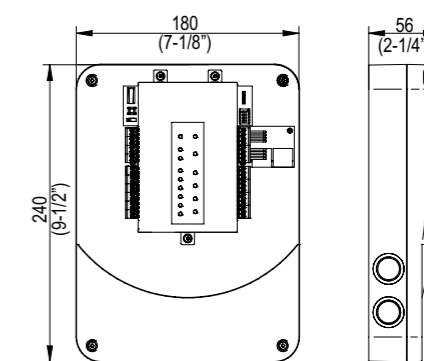

CERTIFICATIONS:



¹ Depending on the cable

CU EXPANSION BOARD - CONTROLLER

CU4EB8 | EXPANSION BOARD

The CU42EB8 provides multi-relay switchable output management to external systems such as lift floor level access, multi-shutter and barrier systems, machine switching and more.



TECHNICAL CHARACTERISTICS:

- Connection to the controller through BUS485.
- 8 relay outputs.
- 4 relay inputs.
- 2 tamper inputs (input, switch).
- The maximum cable length between the I/O board and the controller is up to 400 meters.¹
- Connection to the controller using 2 wire connection, twisted pair.
- Power consumption: 12V DC 400mA, supplied by a power adaptor.

TECHNOLOGY PLATFORMS:



FEATURES:

- Works with the CU42xx.
- Input and output board managed by the controller.
- Software configuration.
- Up to 16 connected units.
- Additional control output relays.
- Compatible with the SALTO ProAccess SPACE alarm event engine module to manage trigger events through inputs when connected to an online network via BUS485.

TECHNICAL DRAWING:

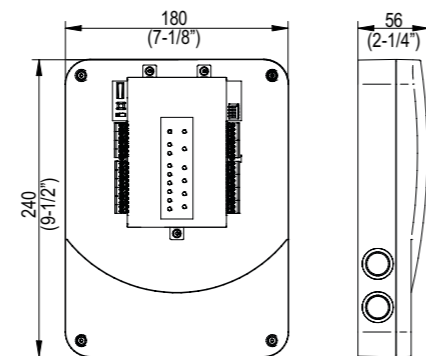

FINISHES:



Translucent housing
CU4EB8T

Grey housing
CU4EB8G

CERTIFICATIONS:



¹ Depending on the cable

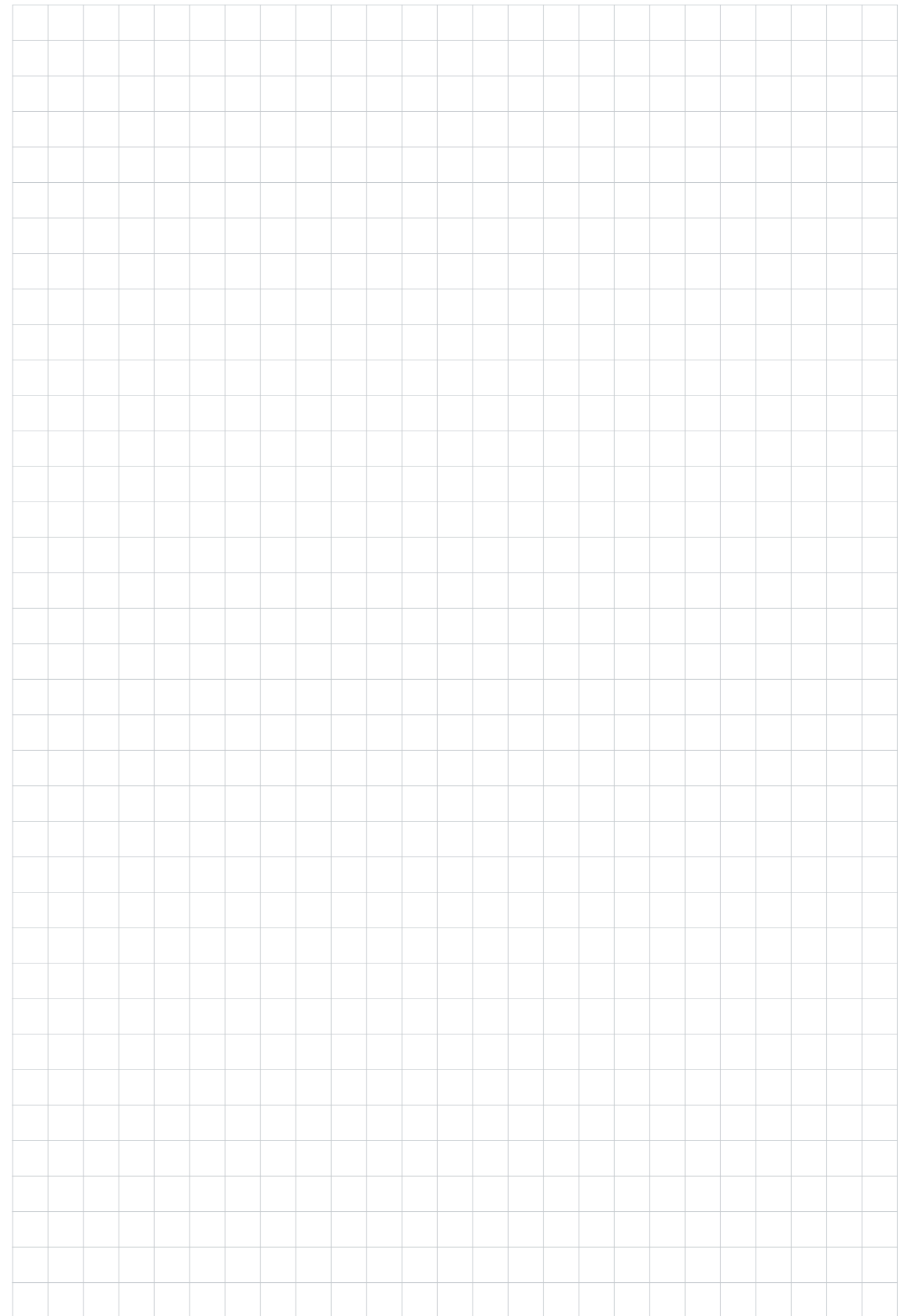

CU SVN ONLINE - CONTROLLER

CU50ENSVN | ONLINE SVN CONTROL UNIT

The SALTO CU50ENSVN is an online door controller that can have one or two wall readers connected, has two control relay outputs and has SALTO Virtual Network (SVN) capabilities. Cards are automatically updated with the latest changes in the access plan. It records the user audit into the PC and provides advanced information on battery status.

It also continually updates the cancelled ID carrier blacklist simply by using the cards on the network, distributing the latest access information throughout the building via the offline stand-alone locks. Access control changes can be carried out on the SALTO software and these are then actioned at the control units in real time. It provides full online features via the networked live link such as door monitoring status, remotely controlling door opening and Roll Call.



FEATURES:

- Online IP door controller 10BASET.
- Two wall reader connections, read in – read out locking.
- Antipassback function.
- Two relay output.
- Compatible with SALTO relay extension board (EB5008) controlling up to 128 relay outputs suitable for lifts, etc.
- Can be used with the SALTO WRMKP for dual identification (Carrier + PIN).
- Request to exit (RTE) switch input.
- Door monitoring and tamper monitoring via contacts input.
- Door status input.

SALTO VIRTUAL NETWORK CAPABILITIES:

- Add or delete access privileges to the ID carriers.
- Validation of key expiration dates on any SVN online wall reader (also when being temporarily offline).
- Card blacklisting from the system.
- On card audit trailing to track staff or visitor movement.
- Lock specific battery power data is registered on any card using the lock – staff or visitor – and transferred back to the PC control software via any update reader just by using the system.

ONLINE FEATURES:

- Same online features as CU50EN.

TECHNICAL CHARACTERISTICS :

- 2 relay outputs.
- Door detector, request to exit switch (RTE), office switch.
- One tamper switch.
- The maximum cable length between the door controller and the wall reader is up to 100 meters.
- Connection to the wall reader using a 5 wire connection, twisted pair.
- Power consumption: 12V DC 400mA (without SALTO readers), supplied by an adaptor.

TECHNOLOGY PLATFORMS:

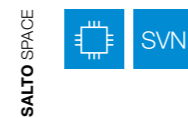

ID TECHNOLOGIES :

- To be used with all SALTO wall readers (except WRM1000, WRDB or WRMB ranges).
- MIFARE® (DESFire EV1, Plus, Ultralight C, Classic - ISO/IEC 14443).
- NFC.
- Inside Picopass.
- LEGIC Prime and LEGIC Advant.
- HID iCLASS®.
- i-Button.

TECHNICAL DRAWING:

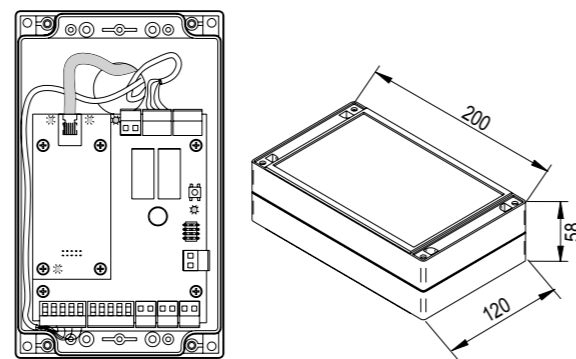

CERTIFICATIONS:



CU STAND-ALONE - CONTROLLER

CU5000 | OFFLINE STAND-ALONE CONTROL UNIT

The SALTO CU5000 is a single door offline door controller that can have one or two wall readers connected and has two control relay outputs.

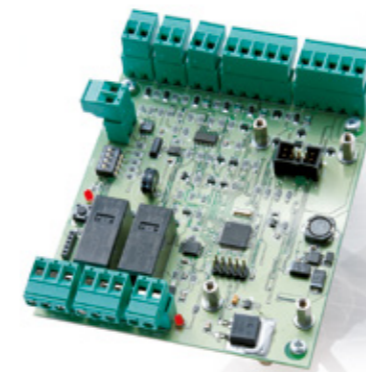

FEATURES:

- Offline door controller.
- Two wall reader connections, read in – read out.
- Antipassback function.
- Two relay output.
- Upgradable to CU50EN or CU50ENSVN.
- Compatible with SALTO relay extension board (EB5008) controlling up to 128 relay outputs suitable for lifts, etc.
- Can be used with the SALTO WRMKP for dual identification (Carrier + PIN).
- Door and tamper monitoring.
- Door status input.

TECHNICAL CHARACTERISTICS:

- 2 relay outputs.
- Door detector, request to exit switch (RTE), office switch.
- One tamper switch.
- The maximum cable length between the door controller and the wall reader is up to 100 meters.
- Connection to the wall reader using a 5 wire connection, twisted pair.
- Power consumption: 12V DC 400mA (without SALTO readers), supplied by a power adaptor.

TECHNOLOGY PLATFORMS:



ID TECHNOLOGIES :

- To be used with all SALTO wall readers (excepted WRM1000, WRDB or WRMB ranges).
- MIFARE® (DESFire EV1, Plus, Ultralight C, Classic - ISO/IEC 14443).
- NFC.
- Inside Picopass.
- LEGIC Prime and LEGIC Advant.
- HID iCLASS®.
- i-Button.

TECHNICAL DRAWING:

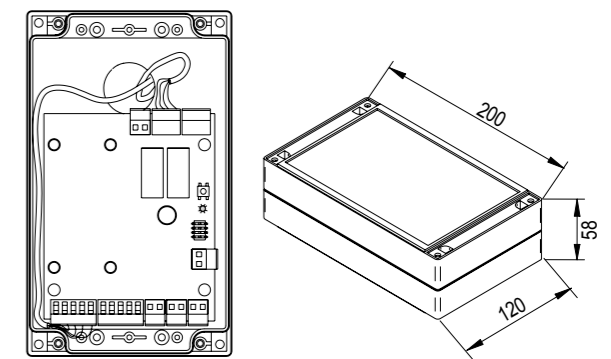

CERTIFICATIONS:

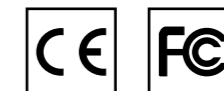

CU EXTENSION BOARD

EB5008 | RELAY EXTENSION BOARD

The EB5008 provides the option to manage multi-relay switchable output systems such as lift floor level access, multi-shutter and barrier systems, machine switching and more.



TECHNICAL CHARACTERISTICS:

- Connection to the controller through BUS485.
- Set up through dip switch.
- 8 relay outputs.
- Connection to the controller using a 2 wire connection, twisted pair.
- Current requires 12V/500mA. Power adaptor included.
- Number of relays each board: 8 (Max. of 16 EB5008 board in series, totalling 128 relay outputs).

TECHNOLOGY PLATFORMS:

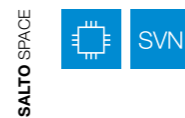

FEATURES:

- Up to 16 EB5008's can be connected in series to 1 door controller, allowing management of up to 128 outputs.
- Each output has user access (triggering) rights controlled from the software.
- Compatible with CU5000, CU50EN or CU50ENSVN door controllers.

TECHNICAL DRAWING:

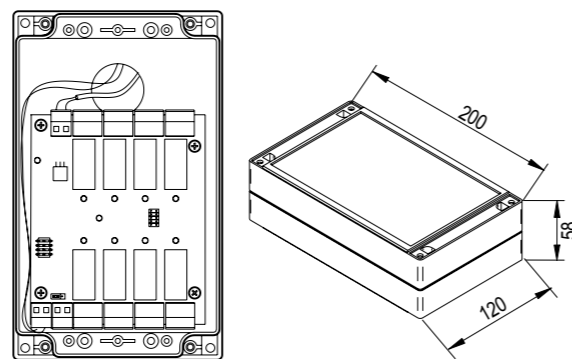

CERTIFICATIONS:



CU INTEGRATION BOARD

CUADAP | SALTO CONTROL UNIT ADAPTOR

The SALTO Control Unit Adaptor opens the integration with third party devices such as time and attendance systems. The Control Unit Adaptor is connected to the CU50ENSVN, sending data and information requested to a third party device. This means that you can access a door with all the convenience of SALTO and control your staff attendance at the same time. The interface with the external device can be RS232, OMRON and Wiegand.



TECHNICAL CHARACTERISTICS:

- To be used with CU5000, CU50EN or CU50ENSVN.
- Configuration by dip switches to control data to be read and the interface with the external device.
- Current required: 12V.
- Connection to the CU: UTP CAT5 cable.
- Connection to the external device: 4 pin block terminal.
- Data read by the CUADAPT: ROM code, tracks on key, Wiegand code.

TECHNICAL DRAWING:

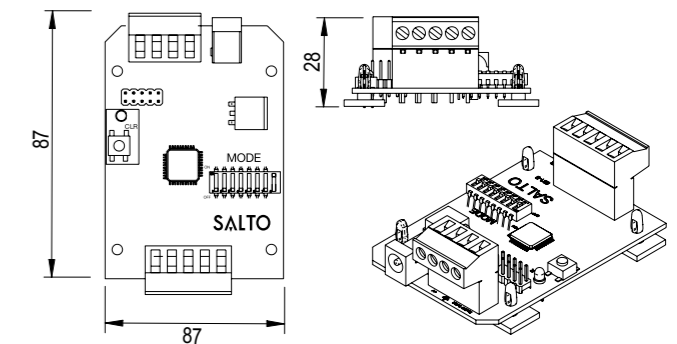

CU INTEGRATION BOARD

WRADAP | SALTO WALL READER ADAPTOR

The SALTO Wall Reader Adaptor opens the integration to third party devices such as time and attendance, POS, etc. The Wall Reader Adaptor is designed to read data from the RW carriers and send it to an external device. The interface with the external device can be RS232, OMRON and Wiegand.



TECHNICAL CHARACTERISTICS:

- Configuration by dip switches to control data to be read and the interface with the external device.
- Voltage required: 12V.
- Connection to the reader: UTP CAT5 cable.
- Connection to the external device: 4 pin block terminal.
- Data read by the WRADAPT: ROM code, tracks on key, Wiegand code.
- To be used with all SALTO wall readers (except WRM1000, WRDB or WRMB ranges).

TECHNICAL DRAWING:

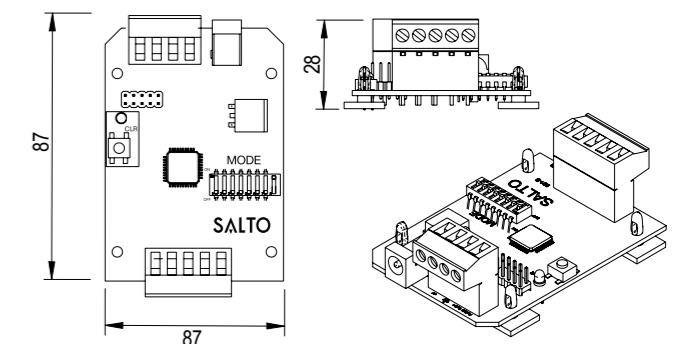



XS4 Locker

XS4 LOCKER LOCK

XS4 Locker Lock

REFERENCE GUIDE

Models

Finishes

XS4 LOCKER | FOR LOCKERS AND CABINETS

The XS4 Locker Lock provides high level security to a wide range of lockers, cupboards, cabinets, boxes, etc. by integrating it into the SALTO wire-free electronic access solution. It features an ergonomically designed twist operated locking

TECHNICAL DATA

POWER SOURCE:

- 3 alkaline batteries (LR03 AAA 1,5V).
Optional 3 Lithium batteries (FR03 - AAA 1,5V - see environmental conditions).

NUMBER OF OPENINGS:

- Up to 40,000 openings, depending on the RFID technology.
- Low battery power indication monitored through the SALTO Virtual Network (SVN).
- The last approx. 1,000 operations are signalled.

ENVIRONMENTAL CONDITIONS:

- - 20°C to +70°C; without condensation (according to EN 60529).
- Inner temperature range: - 0°C to +50°C (-20° / 70° with Lithium batteries; without condensation).
- IP56 rated for protection against ingress of water and dust.

MAIN FEATURES

- Fully integrated with the SALTO Hospitality platform.
- Easy to maintain: Battery change is all that's needed.
- Simple offline installation is possible on many types of small and thin locker doors.
- Door thickness: adaptable on site.
- Outer thumbturn with red/green indicator for availability of the locker, electronically managed release.
- Comes with BioCote® antimicrobial technology.
- Lock with large security deadbolt is built into the locker.
- Ideal for retrofit applications as outside locker lock reader rotates for different door handing and styles.
- No handing.
- Battery pack, electronic components and locking mechanism are all located on the inside of the door, safe from potential vandalism or sabotage.
- All communication between the carrier and the electronic lock is encrypted and secured.
- Low battery status information is obtained from carriers.
- Full access control rights programmed via software.

handle that makes for easy use, even with wet hands. The battery pack, electronic components and locking mechanism are all located on the inside of the door, safe from potential vandalism or sabotage.

ACCESS CONTROL FEATURES

USERS & LOCKERS:

- Maximum number of users per locker: 4 million.
- Maximum number of lockers per system: 65,000.
- Access levels: unlimited.

CALENDARS & TIME ZONES:

- Calendars in system: 256
- Timetables: 1024
- Time periods: 1024

EVENTS:

- Maximum events on locker audit: 1,000.
- Non volatile memory (memory is not deleted, even if power fails).

MANAGEMENT SOFTWARE:

- SALTO ProAccess SPACE.

OPENING MODES

FIXED LOCKER ASSIGNMENT:

A specific user ID carrier operates a specific locker lock.

FREE LOCKER ASSIGNMENT:

Any user ID carrier subsequently used to unlock a locker takes control.

FAMILY OPTION:

Multiple user ID carriers to operate a single locker.

SECURITY CLASS

EN 60529

According to EN 60529 for electronic handle sets including locker lock reader and lock case.

XS4 LOCKER LOCK

XS4 Lx0 | LOCKER LOCK

The SALTO XS4 Locker is a locker lock designed to bring all the advantages of access control to lockers and cabinets. The XS4 Locker is perfect for controlling access to lockers, cupboards, cabinets, boxes and show cases, where access control and full audit trailing are required.



FEATURES:

- Fully integrated with the SALTO XS4 platform.
- Easy to maintain: Battery change is all that's needed.
- Outer thumbturn with red/green indicator for availability of the locker; electronically managed release.
- User on card audit trailing capability via the SALTO Virtual Network (SVN).
- All communication between the carrier and the electronic lock is encrypted and secured.
- Low battery status information is obtained from carriers.
- Full access control rights programmed via software.
- Comes with BioCote® antimicrobial technology.
- Battery pack, electronic components and locking mechanism are all located on the inside of the door, safe from potential vandalism or sabotage.
- Emergency opening through portable programming device (PPD).

READER COLOUR:



TECHNICAL CHARACTERISTICS:

- Simple offline installation is possible on many types of small and thin doors. Door thickness: adaptable on site.
- Inside cover measures: 100mm x 110,5mm x 25mm.
- Outside escutcheon measurements: 54mm x 105mm x 28mm.
- Deadbolt projection: 15mm.
- Lock with large security deadbolt is built into the locker.
- Ideal for retrofit applications as outside locker lock reader rotates for different door handing and styles.
- No handing selection is needed.

TECHNOLOGY PLATFORMS:



ID TECHNOLOGIES :

- MIFARE® (DESFire EV1, Plus, Ultralight C, Classic - ISO/IEC 14443).
- NFC.
- LEGIC Prime and LEGIC Advant.
- HID iCLASS®.

TECHNICAL DRAWING:

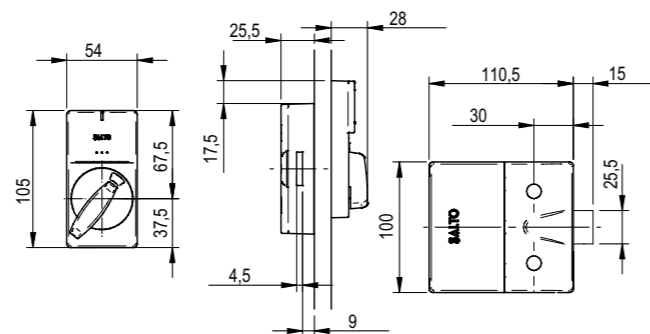

CERTIFICATIONS:

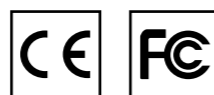

REFERENCE GUIDE INFORMATION

The SALTO XS4 Locker brings the advantages of electronic access control to the locker room. Simple wire-free installation is possible on many types of small and thin doors and available in two different cover colours.

L	90	50	A	20
PRODUCT TYPE	ID TECHNOLOGY	MODEL	FINISH	DOOR THICKNESS
1	2	3	4	5

1 | PRODUCT TYPE

L SALTO XS4 Locker.

2 | ID TECHNOLOGY

RFID

- 8 Contactless LEGIC Advant & Prime.
- 9 Contactless MIFARE DESFire.
- H Contactless HID iCLASS®.

3 | MODEL

50 Standard locker lock.

4 | FINISH

- A Anthracite reader and anthracite battery pack.
- M White reader and anthracite battery pack.

5 | DOOR THICKNESS

20 From 10mm to 20mm.

40 From 30mm to 40mm.

30 From 20mm to 30mm.

50 From 40mm to 50mm.

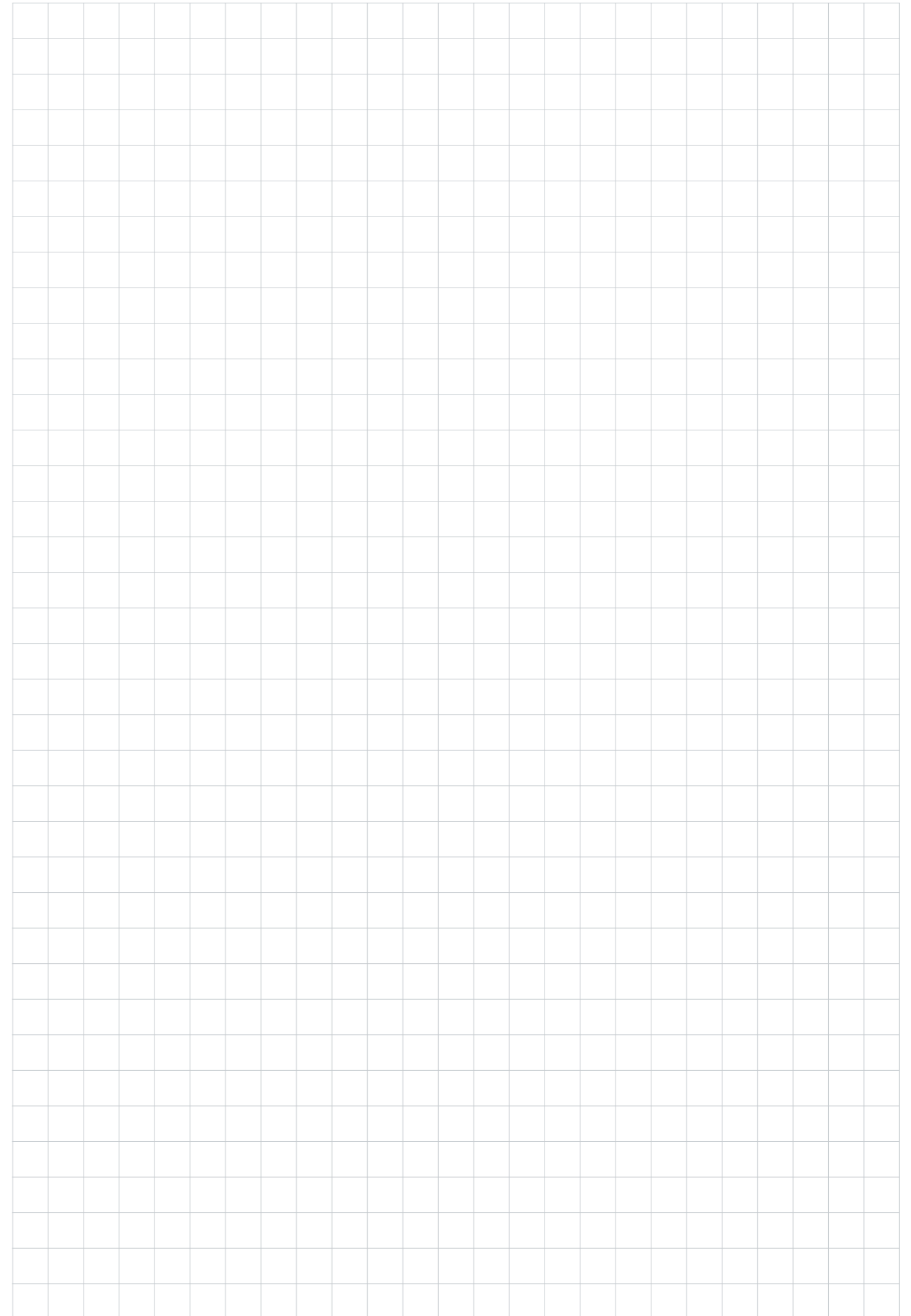

¹White is only available for the exterior part.



XS4 PANIC BARS

ADVANCED EMERGENCY EXIT SOLUTION

SALTO PBE900 Panic Bar

SALTO PBA1200 Panic Bar

SALTO PBF1100 Panic Bar

KITS

SALTO KPBs

XS4 PANIC BARS | EMERGENCY EXIT SOLUTIONS

SALTO Advanced panic bar solutions enable emergency exit doors equipped with panic bars to be controlled with an innovative stand-alone electronic locking system.

TECHNICAL DATA

POWER SOURCE:

- 3 alkaline batteries - LR03 - AAA 1,5V.

NUMBER OF OPENINGS:

- Contactless versions: Up to 40,000 openings.
- Low battery power indication monitored through the SALTO Virtual Network (SVN).
- The last approx. 1,000 operations are signalled.

ENVIRONMENTAL CONDITIONS:

- External lock: -20° / 60°.

MAIN FEATURES

- Fully integrated with the SALTO XS4 platform.
- Simple installation by changing handle set, using just two screws.
- System composed of a SALTO XS4 half escutcheon, a Kit Panic Bar (KPB) and the panic bar (can also be an existing one).
- Existing emergency exits can be retrofitted and upgraded into an electronic stand-alone access control system.
- Easy to maintain: Battery change is all that's needed.
- Wireless capabilities possible to avoid wiring without sacrificing online real-time capabilities.
- User on card audit trailing capability via the SALTO Virtual Network (SVN).
- All communication between the carrier and the electronic lock is encrypted and secured.
- Low battery status information is obtained from carriers.
- Optical signalling through light LED signal. Dual colour green/red to indicate access authorisation.
- The lock can always be opened from the inside (single action panic feature works in conjunction with the panic bar device).
- Available in 2 different finishes: satin stainless steel and polished stainless steel.
- Firmware upgrade through PPD.

SALTO stand-alone electronic locks can be fitted, in combination with adaptor kits, to more than 40 leading panic bars from the most popular manufacturers, whether you have a mortise or a RIM panic device.

ACCESS CONTROL FEATURES

USERS & DOORS:

- Maximum number of users per door: 4 million.
- Maximum number of doors per system: 65,000.
- User access levels: Unlimited.

CALENDARS & TIME ZONES:

- Calendars in system: 256
- Timetables: 1024
- Time periods: 1024

EVENTS:

- Maximum events on lock audit: 2200.
- Non volatile memory (memory is not deleted, even if power fails).

MANAGEMENT SOFTWARE:

- SALTO ProAccess SPACE.

ID TECHNOLOGIES:

- Covering the mainstream RFID technologies.
- Compatible with ISO 14443A, ISO 14443B and ISO 15693 (Vicinity).

LOCK MODES

STANDARD:

Locked at all times.

OFFICE MODE:

Free passage.

TIMED OFFICE:

Automatic locking at end time.

AUTOMATIC OPENING:

8 pairs of "hands free" timed lock and unlocks per day with holidays.

TOGGLE:

Present card to lock, present card to unlock.

TIMED TOGGLE:

Present card to lock, present card to unlock depending on schedules.

AMOK MODE:¹

Local lockdown of the escutcheon for emergency situations.

¹ Depending on the ID technology

XS4 PANIC BAR - EURO

XS4 PBE900 | XS4 PANIC BAR PBF900

The SALTO XS4 PBE900 combines the highest safety standards with ease of use. It is EN1125 compliant in combination with SALTO electronic escutcheons, LE7E31 or LE9E11 SALTO mortise locks, and SALTO KPB (Kit Panic Bars). Its modern, aesthetic design makes it the perfect choice to complement any architectural style.



FEATURES:

- SALTO SVN and SALTO Wireless network capable.
- All communication between the carrier and the electronic cylinder is encrypted and secured.
- Equipped with anti-drilling protection.
- Suitable for medium to high security applications.
- Emergency opening via portable programming device (PPD).
- Available with mechanical cylinder cut outs for key override or access lock outs (override European profile cylinder).
- AMOK option for offline lockdown.

MECHANISM FINISH:



BAR FINISHES:



TECHNICAL CHARACTERISTICS:

- Mortise panic device.
- Mechanisms made of galvanized steel.
- To be installed in combination with Ex450 or Ex650 SALTO half escutcheons depending on the KPB.
- KPB01 or KPB02 required depending on the combination of the half escutcheon and the mortise lock.
- To be used with SALTO LE7E31 or LE9E11 mortise lock ranges.
- Handing DIN left /DIN right usable.
- Maximum wing width: 1300mm.
- Cover dimensions: 200mm x 35mm x 108.5mm
- Spindle angle turn: 30° or 45° depending on the model.
- Square spindle: 9mm.

TECHNOLOGY PLATFORMS:

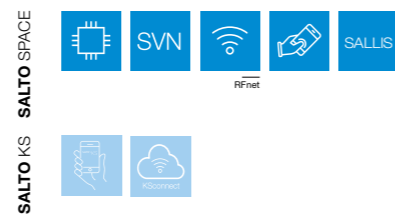

ID TECHNOLOGIES :

Depending on the half escutcheon.

- MIFARE® (DESFire EV1, Plus, Ultralight C, Classic - ISO/IEC 14443).
- Bluetooth SMART (BLE).
- NFC.
- Inside Picopass.
- LEGIC Prime and LEGIC Advant.
- HID iCLASS®.
- i-Button.

TECHNICAL DRAWING:

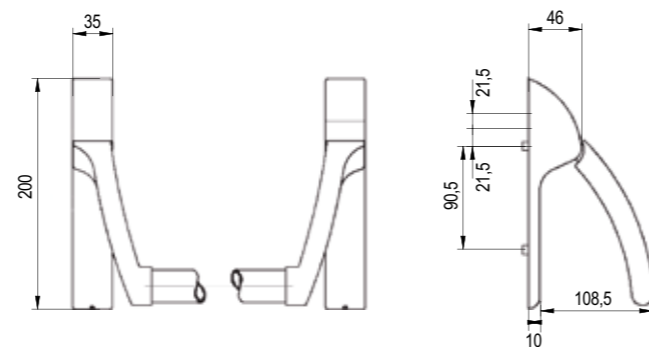

CERTIFICATIONS:

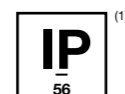

⁽¹⁾ External escutcheon.

XS4 PANIC BAR - EURO

XS4 PBA1200 | XS4 PANIC BAR PBA1200

The SALTO XS4 PBA1200 is a new mortise lock panic bar for emergency exit doors. EN1125 tested and approved. Also available with a passive leaf panic bar for double emergency exit doors.



FEATURES:

- SALTO SVN and SALTO Wireless network capable.
- All communication between the carrier and the electronic cylinder is encrypted and secured.
- Equipped with anti-drilling protection.
- Suitable for medium to high security applications.
- Emergency opening via portable programming device (PPD).
- Available with mechanical cylinder cut outs for key override or access lock outs (override European profile cylinder).
- AMOK option for offline lockdown.

MECHANISM FINISH:



BAR FINISHES:



TECHNICAL CHARACTERISTICS:

- Mortise panic device.
- Mechanisms made of galvanized steel.
- Cover made of satin stainless steel or plastic depending on the finish.
- Finishes: red, green or satin stainless steel (stainless steel version).
- To be installed in combination with Ex450 or Ex650 SALTO half escutcheons depending on the KPB.
- KPB33 required depending on the combination of the half escutcheon and the mortise lock.
- To be used with SALTO LE7A01 mortise lock ranges.
- No handing - reversible.
- Maximum wing width: 1150mm.
- Cover dimensions: 200mm x 35mm x 108.5mm.
- Spindle angle turn: 20° depending on the model.
- Square spindle: 9mm split spindle.

TECHNOLOGY PLATFORMS:

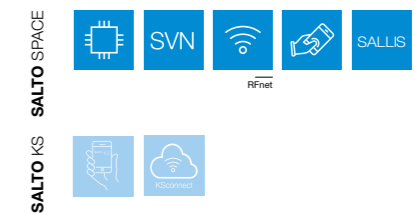

ID TECHNOLOGIES

Depending on the half escutcheon.

- MIFARE® (DESFire EV1, Plus, Ultralight C, Classic - ISO/IEC 14443).
- Bluetooth SMART (BLE).
- NFC.
- Inside Picopass.
- LEGIC Prime and LEGIC Advant.
- HID iCLASS®.
- i-Button.

TECHNICAL DRAWING:

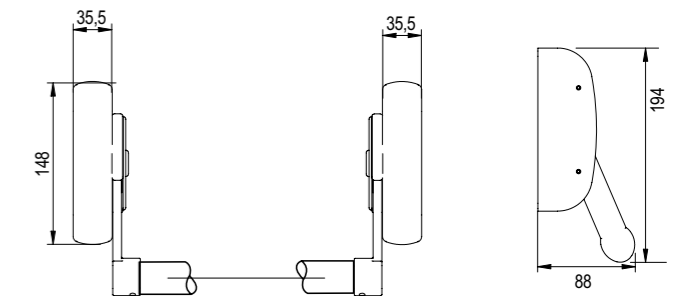

CERTIFICATIONS:

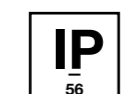

⁽¹⁾ External escutcheon.

XS4 PANIC BAR - PUSH BAR

XS4 PBF110 | XS4 PANIC BAR PBF110

The SALTO XS4 PBF110 device is the emergency exit door's highest standard for security, with enhanced safety performance features. It combines the highest safety along with ease of use and installation. SALTO XS4 PBF110 series exit devices are UL listed for Panic Hardware and Fire Exit Hardware, and are certified according to ANSI A156.3, 2001, Grade 1.



FEATURES:

- SALTO SVN and SALTO Wireless network capable.
- All communication between the carrier and the electronic cylinder is encrypted and secured.
- Equipped with anti-drilling protection.
- Suitable for medium to high security applications.
- Emergency opening via portable programming device (PPD).
- Exit signal when bar depressed.
- AMOK option for offline lockdown.

MECHANISM FINISH:



BAR FINISHES:



IM

TECHNICAL CHARACTERISTICS:

- RIM panic device.
- Latch deadlocking.
- Steel case.
- Can be used with an exterior trim.
- Finishes: Satin stainless steel ANSI/BHMA 630, US32D.
- To be installed in combination with Ai650m00ffH8 / Ai660m00ffH8 + KPBO3xx.
- Latch bolt: Stainless steel 19 mm (3/4") throw.
- Non-handing device.
- Maximum wing width: 1300mm.

TECHNOLOGY PLATFORMS:

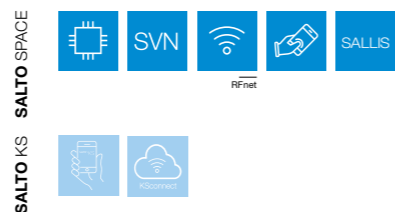

ID TECHNOLOGIES:

Depending on the half escutcheon.

- MIFARE® (DESFire EV1, Plus, Ultralight C, Classic - ISO/IEC 14443).
- Bluetooth SMART (BLE).
- NFC.
- Inside Picopass.
- LEGIC Prime and LEGIC Advant.
- HID iCLASS®.
- i-Button.

TECHNICAL DRAWING:

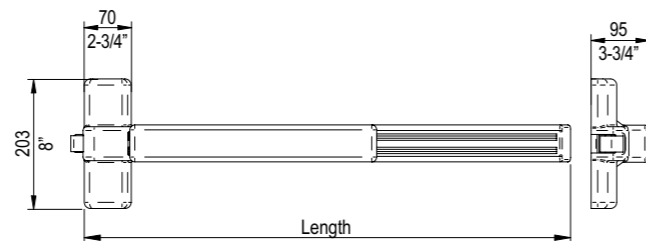

CERTIFICATIONS:



- Certified UL305 and ANSI A156.3-2008, Grade 1
- UL/cUL listed for 3 hour Fire Exit Hardware



⁽¹⁾ External escutcheon.

XS4 PANIC BAR - ADAPTOR KIT

XS4 KPBS | XS4 KIT PANIC BARS

The XS4 SALTO KPBS (Kit Panic Bars) make it possible to fit stand-alone electronic escutcheons in combination with existing panic bars. SALTO has developed a wide range of KPBS that are compatible with the most popular panic bars on the market.



FEATURES:

- Compatible with over 60 types of exit panic devices covering the mainstream market.
- AMOK option for offline lockdown.
- Wireless online in real-time capabilities.
- Two different finishes, satin stainless steel or polished stainless steel.

KPB FINISHES:

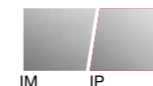

IM IP

TECHNICAL CHARACTERISTICS:

- KPB covers made of stainless steel.
- Customized fixing systems depending on the panic bar to be adapted.
- Compatible with some concealed vertical rod panic bars.

TECHNOLOGY PLATFORMS:

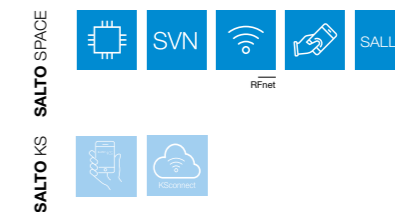

ID TECHNOLOGIES:

Depending on the half escutcheon.

- MIFARE® (DESFire EV1, Plus, Ultralight C, Classic - ISO/IEC 14443).
- Bluetooth SMART (BLE).
- NFC.
- Inside Picopass.
- LEGIC Prime and LEGIC Advant.
- HID iCLASS®.
- i-Button.

TECHNICAL DRAWING:

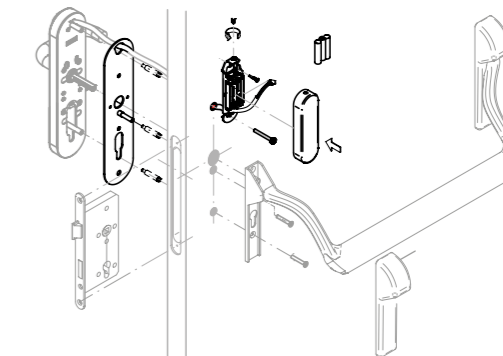

CERTIFICATIONS:

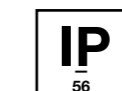

⁽¹⁾ External escutcheon.



Mortise Locks

EUROPEAN MORTISE LOCKS

LE7S Models (PZ 72)

LE8P Models (PZ 85)

LE7W Models (PZ 92)

LE9W Models (PZ 92)

SCANDINAVIAN MORTISE LOCKS

LS5N Models

ANSI MORTISE LOCKS

LA1T Models (ANSI Grade 1)

CARTRIDGE CYLINDRICAL LATCHES

LC1M Models (ANSI Grade 1)

TUBULAR LATCHES

LT2K Model

MORTISE LOCKS | RELIABLE LOCKING

Access control requires a good, reliable door smart locking system. SALTO offers a wide range of mortise locks in order to ensure that the door is correctly locked. Whether you need ANSI mortise locks, Euro DIN locks for wooden doors or narrow profiles, Scandinavian locks, cylindrical

cartridge latches or automatic locks with privacy and panic functions, SALTO has the locking system you need. Our complete range of mortise locks enable you to install SALTO electronic escutcheons and cylinders without compromising security.

MAIN FEATURES

- Lock case, latch and deadbolt made of steel.
- ANSI, Euro locks, DIN locks (distances 72mm, 85mm and 92mm), SIS Scandinavian standard and cylindrical latch models.
- Wide range of backsets and front plate configurations to fit most doors.
- Optional panic function for greater security of users or guests.
- Equipped with auxiliary latch (anti card system) to prevent unwanted intrusions.
- Highest certifications compliant.*
- With automatic deadbolt or latch through-in option.
- Optional with door detector to monitor the status of the door without any additional hardware.*
- Optional with deadbolt detector for electronic privacy function.
- Optional key override function for greater security of users or guests.

* Depending on the mortise lock model, the certifications can vary.



EUROPEAN MORTISE LOCK

LE7S | DIN EUROPEAN MORTISE LOCK

The SALTO XS4 LE7S is a DIN compatible mortise lock that offers a wide range of operations and functions possibilities to improve access control with a reliable locking solution.

It includes integrated electronic detectors* to monitorize in real-time the door status, providing an easy to install solution without any additional hardware or drilling needs.



FEATURES:

- DIN compatible mortise lock case, according to DIN 18251.
- Suitable for XS4 Euro standard escutcheons and electronic cylinders.
- High resistance by use of high quality materials.
- Lock case, latch made of steel.
- Equipped with auxiliary latch (anti card system) to prevent unwanted intrusions.
- Different backsets.
- Optional asymmetric front plate for rebated doors.
- Includes standard strike plate and dust box for an optimal installation.
- Requires no extra drilling.
- Strike plate and dust box included.

FINISHES:



TECHNICAL CHARACTERISTICS:

- Axe distance: 72mm.
- Compatible with Euro profile mechanical cylinders.
- Round or squared front plate available.
- 8mm or 9mm square spindle.
- Turning angle: 23°.
- Backsets available: 55mm, 60mm, 65mm and 70mm.
- Front plates available: 20mm and 24mm.

HANDING:

- Reversible latch with antifriction for more convenient and reliable function.
- Optional asymmetric front plate for rebated doors.

TECHNICAL DRAWING:

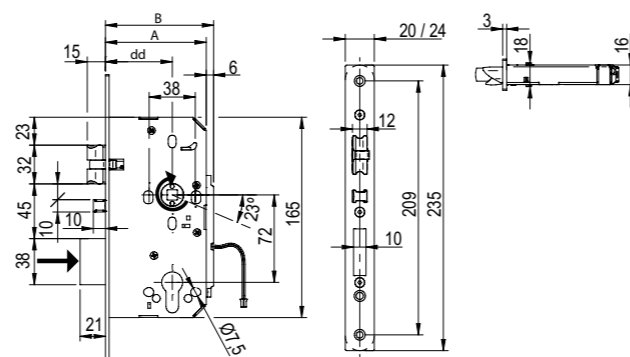

OPERATIONS AND FUNCTIONS:

- Intelligent integrated detectors for deadbolt and door position to monitor the status of the door without any additional hardware or fitting.*
- Detection of intrusion alarms.*
- Opened and closed status of doors through SALTO Wireless technology.*
- Optional integrated electronic privacy detector for door/room status real-time monitoring.*
- Anti-panic safety function: In locked position, turning the inside handle retracts auxiliary latch and deadbolt simultaneously.
- Mortise lock available with or without deadbolt for additional security.
- The handle retracts the latch to normal position.
- 1 turn thumbturn full projection.

CERTIFICATIONS:



EUROPEAN MORTISE LOCK

LE8P | EUROPEAN MORTISE LOCK

The XS4 Euro lock is a mortise lock with latch projection which means the latch is automatically projected and deadlocked when the door is closed. This mortise lock is suitable for all kinds of wooden doors, whether it's a hotel room, office or warehouse door, etc. The new latch projection function increases security by making it impossible to gain access by using plastic cards.

For additional security, SALTO also offers the option to order this lock with a deadbolt.



FEATURES:

- European mortise lock case.
- Suitable for XS4 Euro standard escutcheons and electronic cylinders.
- High resistance by use of high quality materials.
- Lock case, latch and deadbolt made of steel.
- Different backsets.
- Strike plate and dust box not included.

FINISHES:

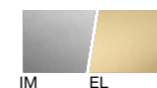

TECHNICAL CHARACTERISTICS:

- Axe distance: 85mm.
- Compatible with Euro profile mechanical cylinders.
- Round or squared front plate available.
- 8mm square spindle.
- Turning angle: 28°.
- Backsets available: 50mm, 60mm and 70mm.
- Front plates available: 20mm and 23mm.
- ANSI front plates available: 27mm and 32mm for ANSI retrofit.

HANDING:

- Reversible latch for more convenience.

TECHNICAL DRAWING:

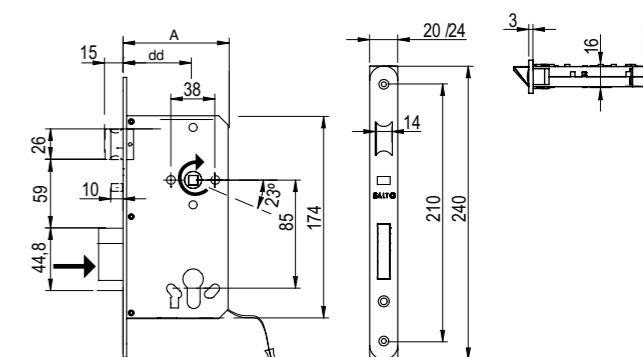

OPERATIONS AND FUNCTIONS:

- Mortise lock available with or without deadbolt for additional security.
- Mortise lock with self-locking action projection (5mm projection) to prevent unwanted intrusions.
- The handle retracts the latch to normal position.
- Anti-panic safety function: In locked position, turning the inside handle retracts auxiliary latch and deadbolt simultaneously.
- Deadbolt detector option for electronic privacy function.
- Optional integrated detectors for electronic privacy function to monitor the status of the door without any additional hardware or fitting.

CERTIFICATIONS:



* Depending on the model

EUROPEAN MORTISE LOCK

LE7W | DIN EUROPEAN AUTOMATIC MORTISE LOCK

The XS4 DIN Mortise lock LE7W is an automatic deadbolt projection mortise lock that fits the DIN standards. This mortise lock is secure and robust, as it has an intelligent system that projects the deadbolt automatically when the door is closed to ensure that it is properly locked.



TECHNICAL CHARACTERISTICS:

- Axe distance 72mm.
- Compatible with Euro profile mechanical cylinders.
- Round or squared front plate available.
- 8mm or 9mm square spindle.
- Turning angle ca.30°.
- Backsets available 55mm, 60mm, 65mm and 80mm.
- Front plates available: 20mm and 24mm.

HANDING:

- Handed lock, not reversible.

TECHNICAL DRAWING:

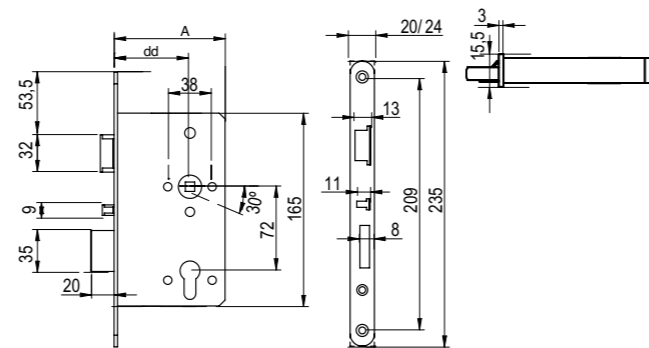

FEATURES:

- DIN mortise lock case.
- Suitable for XS4 Euro standard escutcheons and electronic cylinders.
- High resistance by use of high quality materials.
- Lock case, latch and deadbolt made of steel.
- Equipped with auxiliary latch (anti card system) to prevent unwanted intrusions.
- Different backsets.
- Strike plate and dust box not included.

FINISHES:



IM

OPERATIONS AND FUNCTIONS:

- Automatic deadbolt projection.
- The handle retracts the latch to normal position.
- Anti-panic safety function: In locked position, turning the inside handle retracts auxiliary latch and deadbolt simultaneously.

CERTIFICATIONS:

Certificates of conformity from the lock manufacturer.

EUROPEAN MORTISE LOCK

LE9W | DIN EUROPEAN MORTISE LOCK

SALTO offers different mortise locks suitable for narrow profile doors. The LE9W is a mortise lock compatible with DIN lock cases that offers a high quality product, and also allows use with an automatic deadbolt projection.



TECHNICAL CHARACTERISTICS:

- Axe distance 92mm.
- Compatible with Euro profile mechanical cylinders.
- Squared front plate available.
- 9mm square spindle (adaptor to 8mm included).
- Turning angle 30°.
- Backsets available 30mm, 35mm, 40mm and 45mm.
- Front plates available: 24mm.

HANDING:

- Reversible latch for more convenience.

TECHNICAL DRAWING:

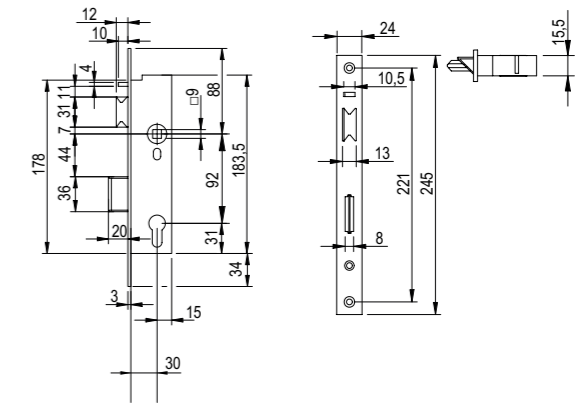

FEATURES:

- European mortise lock case.
- Suitable for XS4 Euro standard escutcheons and electronic cylinders.
- High resistance by use of high quality materials.
- Lock case, latch and deadbolt made of steel.
- Different backsets.
- Strike plate included.

FINISHES:



IM

OPERATIONS AND FUNCTIONS:

- Mortise lock available with or without deadbolt for additional security.
- Automatic deadbolt projection optional for more security.
- The handle retracts the latch to normal position.
- Anti-panic safety function: In locked position, turning the inside handle retracts auxiliary latch and deadbolt simultaneously.

CERTIFICATIONS:

Certificates of conformity from the lock manufacturer.

NORDIC MORTISE LOCK

LS5N | SCANDINAVIAN MORTISE LOCK

Wide range of specially designed Scandinavian standard mortise locks that ensure the door is locked correctly and securely. Developed to increase both the security and safety of the entire door, especially when used with access control and building key management systems. Suitable for use with Scandinavian XS4 Nordic escutcheons, XS4 Nordic Mini electronic locks and XS4 Nordic GEO cylinder models on both interior and exterior doors.



TECHNICAL CHARACTERISTICS :

- Axe distance 105mm.
- Compatible with Scandinavian oval and round type cylinder.
- Round front plate available.
- 8mm square spindle.
- Turning angle 33°.
- Backsets available 50mm.
- Front plates available: 22mm.

HANDING:

- Handed lock, not reversible.

TECHNICAL DRAWING:

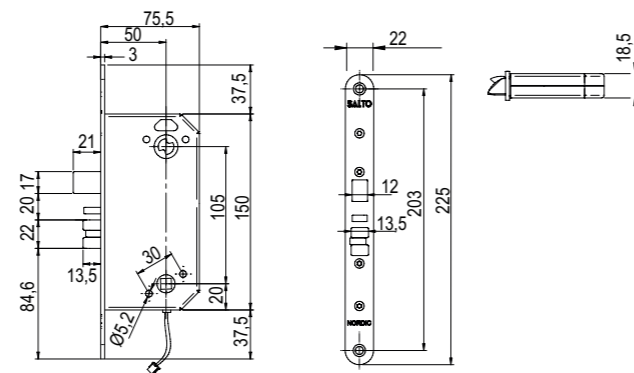

FEATURES:

- Scandinavian standard mortise lock.
- Suitable for XS4 Nordic standard escutcheons and electronic cylinders.
- High security lock for exterior and interior Scandinavian standard doors.
- Scandinavian oval and round type cylinder compatible.
- Lock case, latch and deadbolt made of zinc plated steel.
- Equipped with auxiliary latch (anti card system) to prevent unwanted intrusions.
- Scandinavian standard strike plate available for an optimal installation.

FINISHES:



OPERATIONS AND FUNCTIONS:

- Intelligent integrated detectors for deadbolt and door position to monitor the status of the door without any additional hardware or fitting.*
- Detection of intrusion alarms.*
- Opened and closed status of doors through SALTO Wireless technology.*
- Optional integrated electronic privacy detector for door/room status real-time monitoring.*
- Anti-panic safety function: In locked position, turning the inside handle retracts auxiliary latch and deadbolt simultaneously.
- Mortise lock available with or without deadbolt for additional security.
- The handle retracts the latch to normal position.

CERTIFICATIONS:



* Depending on the model

ANSI MORTISE LOCK

LA1T | ANSI MORTISE LOCK

Specially designed for those doors that need an ANSI mortise lock ANSI A 156.13 Grade 1 and a privacy function with a deadbolt for Hospitality purposes.

It includes integrated electronic detection to monitorize in real-time the door status, providing an easy to install solution without any additional hardware or drilling needs.



TECHNICAL CHARACTERISTICS :

- Axe distance 62mm.
- Compatible with mortise cylinders 1-1/8".
- Squared front plate.
- 8mm (5/16") square spindle.
- Turning angle 54°.
- Backsets available: 70mm.
- Front plates available: 32mm (1-1/4"x8") and 27mm (1-1/16"x 8").

HANDING:

- Reversible latch for more convenience.
- Adjustable face plate.

TECHNICAL DRAWING:

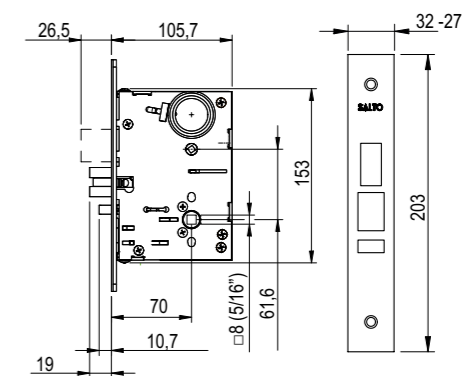

FEATURES:

- Grade 1 ANSI mortise lock case.
- Suitable for ANSI standard escutcheons and electronic cylinders.
- High security heavy duty mortise lock for exterior and interior ANSI standard doors.
- Lock case, latch and deadbolt made of steel.
- Equipped with auxiliary latch (anti card system) to prevent unwanted intrusions.
- Includes standard strike plate and dust box for an optimal installation.

FINISHES:



OPERATIONS AND FUNCTIONS:

- Intelligent integrated detectors for deadbolt and door position to monitor the status of the door without any additional hardware or fitting.
- Detection of intrusion alarms.
- Opened and closed status of doors through SALTO Wireless technology.
- Optional integrated electronic privacy detector for door/room status real-time monitoring.
- Anti-panic safety function: In locked position, turning the inside handle retracts auxiliary latch and deadbolt simultaneously.
- Mortise lock available with or without deadbolt for additional security.
- The handle retracts the latch to normal position.

CERTIFICATIONS:



CYLINDRICAL LATCH

LC1K | CARTRIDGE CYLINDRICAL LATCH

With the SALTO XS4 cylindrical latch, you can replace existing traditional knob sets and upgrade them with a state of the art electronic access control system.

SALTO Cartridge cylindrical latches meet ANSI A156.2 Grade 1 requirements, and enable users to replace old cylindrical or tubular latches with new, high quality ones compatible with SALTO electronic escutcheons.

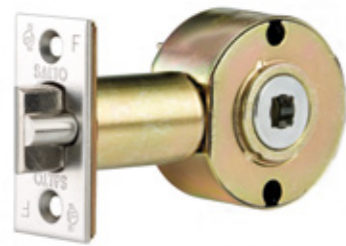

TECHNICAL CHARACTERISTICS :

- Squared front plate.
- 8mm ($\frac{5}{16}$ ") square spindle.
- Turning angle 58°.
- Backsets available: 60mm ($2\frac{3}{8}$ "), 70mm ($2\frac{7}{8}$ "), 95mm ($3\frac{3}{4}$ ") and 127mm (5").
- Front plates available: 28,6mm ($1\frac{1}{8}$ ") x 57,2mm ($2\frac{1}{4}$ ")

HANDING:

- Symmetrical latch for more convenience, no handing needed.

TECHNICAL DRAWING:

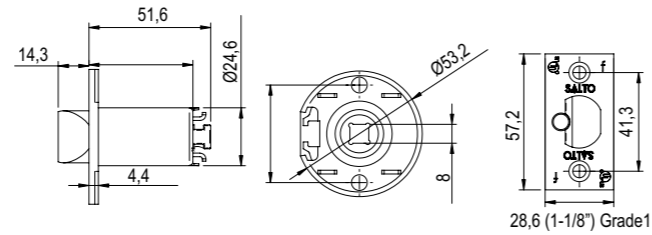

FEATURES:

- Meets ANSI A156.2 Grade 1 cylindrical latch requirements.
- Suitable for XS4 Original ANSI standard escutcheons and XS4 Mini ANSI models.
- Cartridge, latch and deadbolt made of steel.
- Equipped with auxiliary latch (anti card system) to prevent unwanted intrusions.
- Different backsets.
- Strike plate and dust box included.

FINISHES:

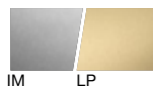

OPERATIONS AND FUNCTIONS:

- The handle retracts the latch to normal position.

CERTIFICATIONS:



TUBULAR LATCH

LT2K | TUBULAR LATCH

The SALTO LT2K tubular latch is a Grade 2 tubular latch that permits combining SALTO electronic escutcheons on doors where a tubular latch retrofit is needed.



TECHNICAL CHARACTERISTICS :

- 12,7mm ($\frac{1}{2}$ ") throw solid brass latch.
- Squared front plate.
- 8mm square spindle.
- Turning angle 40°.
- Backsets available 60mm, 70mm and 127mm.
- Front plates available: 25,4mm (1").

HANDING:

- Symmetrical latch for more convenience, no handing needed.

TECHNICAL DRAWING:

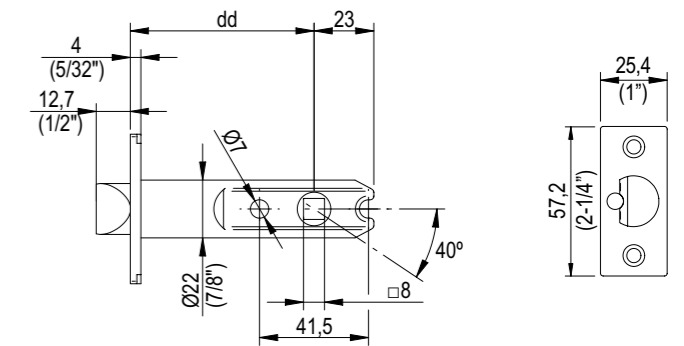

FEATURES:

- Meets ANSI A156.2 Grade 2 tubular latch requirements. Latch and body made of steel.
- Suitable for XS4 standard escutcheons.
- Equipped with auxiliary latch (anti card system) to prevent unwanted intrusions.
- Different backsets.
- Strike plate and dust box included.
- Satin stainless steel finish (US32D).

FINISHES:



OPERATIONS AND FUNCTIONS:

- The handle retracts the latch to normal position.

REFERENCE GUIDE INFORMATION

LOCK | MORTISE LOCKS

SALTO offers a wide range of mortise locks in order to ensure that the door is correctly locked. Whether you need Euro locks, DIN locks, ANSI mortise locks, Scandinavian standard locks, cylindrical cartridge latches or automatic locks with privacy and panic functions, SALTO has the locking system you need.

The complete range of standard mortise locks enables you to install SALTO electronic XS4 escutcheons and SALTO XS4 GEO cylinders without compromising security.

LE	7S	15	15	60	R	4	3	IM	8	-
PRODUCT TYPE	SERIES	DEADBOLT FUNCTION	LATCH FUNCTION	BACKSET	FRONT PLATE SHAPE	FRONT PLATE	DETECTOR	FINISH	SPINDLE	HANDING
1	2	3	4	5	6	7	8	9	10	11

1 | PRODUCT TYPE

LE	European mortise lock.
LA	ANSI mortise lock.
LS	Scandinavian mortise lock.
LC	Cylindrical latch.
LT	Tubular latch.

2 | SERIES

7S	DIN European mortise lock (Axe distance 72mm).
8P	European mortise lock with automatic latch projection (Axe distance 85mm).
7W-7E	DIN European automatic mortise lock (Axe distance 72mm).
9W-9E	DIN European mortise lock (Axe distance 92mm).
1T-1M	ANSI mortise lock Grade 1.
2K	ANSI tubular latch Grade 2.
5N	Scandinavian mortise lock (Axe distance 105mm).

3 | DEADBOLT FUNCTION

0	No deadbolt.
1	Deadbolt with panic function.
2	Deadbolt without panic function.
3	Automatic deadbolt projection.

4 | LATCH FUNCTION

0	No latch.
1	Standard latch.
2	Automatic latch projection.
4	Latch with anti-friction system.

5 | BACKSET

30	30mm.	50	50mm.	70	70mm.
35	35mm.	55	55mm.	27	127mm.
40	40mm.	60	60mm.		
45	45mm.	65	65mm.		

Not all the backsets are available in all versions.

6 | FRONT PLATE SHAPE

C	Squared.
R	Round.
A	ANSI Type.

7 | FRONT

0	20mm.	7	27mm.
2	32mm.		
4	24mm.		

8 | DETECTOR

0	No detector.
1	Built-in deadbolt detector (privacy system).
2	Built-in door detector.
3	Built-in deadbolt (privacy system) and door detector.

9 | FINISHES

IM	Satin stainless steel (US32D).
EL	Brass.
LP	Polished brass (US3).
ZP	Zinc plated.

10 | SPINDLE

8	8mm through squared spindle.
9	9mm through squared spindle.

11 | HANDING

-	No handing.
L	Left hand.
R	Right hand.

11 | SALTO and ANSI mortise lock handing code

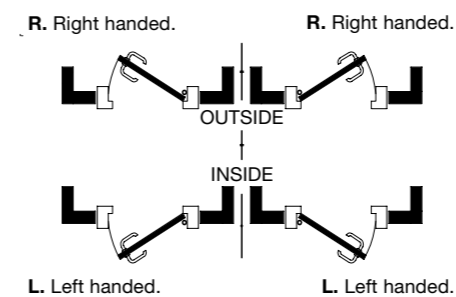

11 | Scandinavian and DIN mortise lock handing code

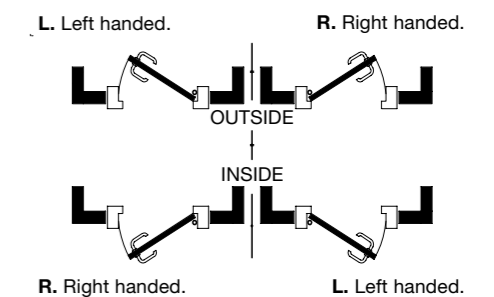

SALTO SPACE Platform components

SALTO SPACE PLATFORM COMPONENTS

Wireless System Components

Energy Saving Devices (ESD)

Access Control Management Tools

Credentials

SALTO SPACE | PLATFORM COMPONENTS

The SALTO SPACE platform is more than just a locking solution and by combining the locks with other devices, we can reach a level of convenience and performance higher than traditional stand-alone access control systems.

MAIN FEATURES

The XS4 online advanced wireless solution delivers real-time high level security with all the convenience of battery-operated access control.

It's the perfect choice for applications that need an access control system with low power consumption, providing online control without any need to hard-wire.

Simply set up the gateways (which are connected by Ethernet/WIFI to the controlling PC) and Nodes in pre-defined wireless zones and you're ready to go. The battery powered escutcheons and electronic cylinders use built-in low power radio transceivers to communicate with the gateways to create a real-time wireless access control network.

WIRELESS ACCESS CONTROL PLATFORM COMPONENTS:

- **GATEWAY:** The SALTO Gateway is the link between the PC and the wireless network.
- **NODE:** The SALTO Node is a bridge between the gateway and the wireless door lock.

MANAGEMENT TOOLS

The two SALTO SPACE technology platform management tools are the link between the software and the carriers as well as between the software and the locks on the door. To perform routine tasks such as editing new user keys, set up the access control plan, run diagnostics on offline devices, or perform emergency openings in extreme situations and more.

SALTO SPACE PLATFORM COMPONENTS:

- **ENCODER:** The SALTO XS4 encoder is a compact device which reads, encodes and updates carriers.
- **CONTACTLESS PPD:** The SALTO Portable Programming Device is the messenger between the computer and the locks.

ENERGY SAVING DEVICES

The SALTO in-room energy saving device (ESD) helps save up to 65%* of a hotel room or student dorm's electricity consumption. Unlike standard (magnetic stripe) energy savers, only authorized SALTO key cards will switch on the lights.

It is also available in a connected online version, which as well as energy saving, indicates in real-time the presence of guests or staff in a room, logging the information directly into the building management PC.

SMART ENERGY SAVING DEVICES (ESDs):

- **RFID:** Recognizes RFID user's cards and switches on only the electrical equipment they need to do their work.
- **i-BUTTON:** Recognizes user's i-Button keys and switches on only the electrical equipment they need to do their work.

* SALTO statistics.

CREDENTIALS

SALTO carriers are available in a wide range of versions to suit every user's individual needs. Contactless and intuitive to use, you just have to present the carrier at the reader. All carriers are battery free, waterproof, copyproof and also suitable for multi-applications with other systems like T&A terminals or cashless payment systems.

CONTACTLESS IDENTIFICATION KEYS:

- **CARDS:** Contactless RFID cards.
- **FOBS:** Contactless RFID key fobs.
- **BRACELETS:** Contactless RFID bracelets.

BLUENet WIRELESS GATEWAY

BLUENET GATEWAY | WIRELESS COMPONENTS

The SALTO Gateway is the link between the PC and the wireless network. Completely managed through SALTO ProAccess SPACE software, it collects all the information sent by the escutcheons through the nodes.



TECHNICAL CHARACTERISTICS :

- Frequency range: 2400-2483,5 Mhz.
- RF standard: Bluetooth Low Energy (BLE).
- Indoor radio range: 10/15m.
- Max output power: 8dBm.
- AES 128 bit encryption.
- Connection to the LAN Network 10 BASE-T/100 BASE-TX.
- PoE supported IEEE802.3af (12V power adapter optional).
- Can manage several nodes and many locks.
- IP addressing through web explorer available.
- Firmware update via software through Ethernet connection.
- One internal node included.

TECHNICAL DRAWING:

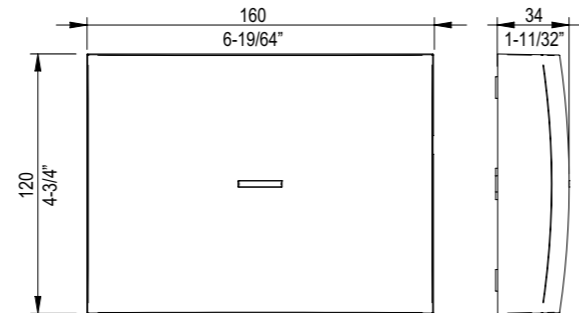

GATEWAY COLOUR:



ENERGY SAVING DEVICE

ESD | ENERGY SAVING DEVICE

The SALTO in room energy saving device (ESD) helps to save up to 65%* of a hotel room or student dorm's electricity consumption and unlike standard (magnetic stripe) energy savers, only authorized SALTO key cards will switch on the lights. Any other card (frequent flyer, business card, etc.) or other SALTO cards belonging to other rooms, won't work.



TECHNICAL CHARACTERISTICS :

- Input voltage: 85-265 Volts AC.
- Consumption:
 - 200 mW in rest mode.
 - 1,8 W when activated.
- Relay power cut: 10A.
- Max. section for power and relays contacts connector:
 - Stranded wire section: 12 AWG (2,5mm2).
 - Strip length: 4-5mm.
- Max. section for windows detector connector:
 - Stranded wire section: 16 AWG (0,5mm2).
 - Strip length: 4-5mm.

TECHNOLOGY PLATFORMS:



ID TECHNOLOGIES :

- MIFARE, MIFARE plus, MIFARE Ultralight C, DESFire, DESFire EV1.
- i-Button.

FEATURES:

- Two different finishes for different room styles.
- Two relay outputs.
- Window detector input. If window is left open, the system will switch off the air conditioning.
- Flexible exit time delay by software.
- Modern blue LED indicator which indicates the location of the device in the dark, and blinks as a courtesy indicator after retrieving the card when leaving the room.
- Available in i-Button and RFID (Mifare, DESfire, Mifare Ultralight).
- Online version available in RFID models.

FINISHES:



Gold champagne
ESDx2UC

Iron blue
ESDx2UI

TECHNICAL DRAWING:

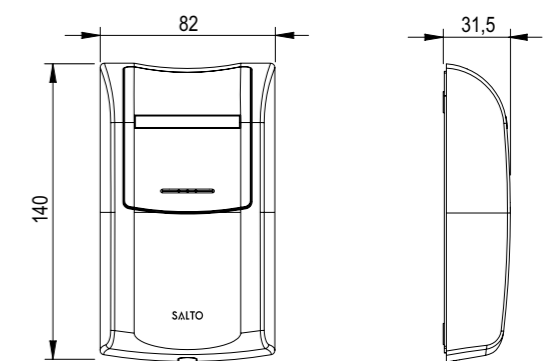

CERTIFICATIONS:



BLUENet WIRELESS NODE

BLUENET NODE | WIRELESS COMPONENTS

The SALTO Node is a bridge between the gateway and the escutcheons, where the distance to the escutcheon or where the number of escutcheons that must be linked to the gateway exceeds what is possible with a single gateway.



TECHNICAL CHARACTERISTICS :

- RF standard: Bluetooth Low Energy (BLE)
- AES 128bits encryption.
- Connection to the gateway BUS 485.
- Powered by the gateway.
- Can manage up to 16 wireless locks.
- Firmware update via software through Ethernet connection.

TECHNICAL DRAWING:

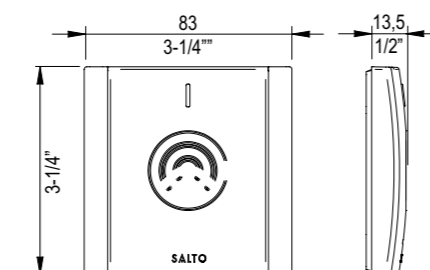

ENCODER

ECx0EN/ECx0USB | PLATFORM COMPONENTS

The SALTO encoder is a compact device which reads, encodes and updates cards.

It is available in different versions depending on the PC connection (Ethernet or USB). It also permits automatic key issuing in large and complex properties, enabling users to carry out key assignment without any assistance required from the access control manager.



TECHNICAL CHARACTERISTICS :

- Current required: 12 v/ 500mA (adaptor included).
- Connection to the PC: USB or Ethernet.
- USB encoders do not usually require an external adaptor.

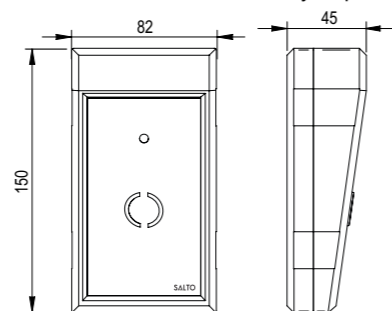

TECHNOLOGY PLATFORMS:



ID TECHNOLOGIES :

- MIFARE, MIFARE plus, MIFARE Ultralight C, DESFire, DESFire EV1.
- Inside Picopass.
- LEGIC Prime and LEGIC Advant.
- HID iCLASS®.
- i-Button.

DESKTOP READER

ECx0DR | PLATFORM COMPONENTS

Created for the Hotel environment, the SALTO desktop reader is designed to read data from the R&W carriers and send it to an external device, usually a Point of Sale terminal.



TECHNICAL CHARACTERISTICS :

- Configuration by dip switches to control data to be read and the interface with the external device.
- The interface with the external device can be RS232, OMRON and WIEGAND.
- Current required: 12v DC source (included).
- Connection to the external device: 9 pin D-type female connector (to be connected to serial port).
- Data read by the desktop reader: ROM code, tracks on key, Wiegand code.

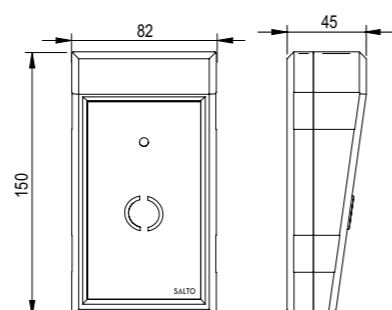

ID TECHNOLOGIES :

- MIFARE, MIFARE plus, MIFARE Ultralight C, DESFire, DESFire EV1.
- Inside Picopass.
- LEGIC Prime and LEGIC Advant.
- HID iCLASS®.
- i-Button.

TECHNOLOGY PLATFORMS:



PORTABLE PROGRAMMING DEVICE

PPDx00 | PLATFORM COMPONENTS

The SALTO contactless Portable Programming Device (PPD) is the messenger between the computer and the locks such as escutcheons or cylinders. It is used by system administrator staff to test or program the locks, initialize doors, update locks or collect audit trails.



TECHNICAL CHARACTERISTICS :

- Power source: 3 alkaline batteries - LR03 - AAA 1,5V.
- Membrane keyboard.
- Adaptive brightness to correct screen.
- Connection to lock: cable included or contactless through NFC.
- PC connection: USB.

TECHNOLOGY PLATFORMS:

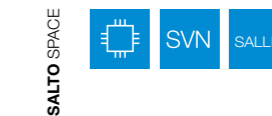

ID TECHNOLOGIES :

- Contactless RFID.
- i-Button.

FEATURES:

- Multilingual interface that facilitates the maintenance operations.
- Initialise doors: Transmits the door's access plan where the lock, reader or cylinder is installed.
- Collect audit trail: Download all the register of events from the locks, readers or cylinders.
- Update locks (door profile & internal clock).
- Door diagnostic.
- Emergency opening.
- Firmware update.
- Auto switch-off.
- Low-battery indication.

TECHNICAL DRAWING:

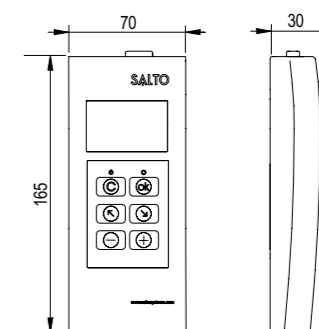

CERTIFICATIONS:



CARRIERS - CARDS

CREDENTIALS | PLATFORM COMPONENTS

Reusable, contactless RFID smart cards for access control. It provides higher levels of security than traditional mechanical key management and additional applications can be implemented on the same ID user credential.



TECHNICAL CHARACTERISTICS :

- Available in 1 Kbytes / 4 Kbytes of memory
- Available in white, SALTO design and other design (under request).
- Meets requirements for contactless access control and compatible with SALTO Virtual Network data-on-card technology.
- Same size and thickness as a standard credit card.

COLOURS:



TECHNOLOGY PLATFORMS:



ID TECHNOLOGIES :

- MIFARE® DESFire EV2.
- MIFARE® Classic.
- MIFARE® Ultralight C.
- LEGIC Prime and LEGIC Advant.
- HID iCLASS®.
- Designed for multiple applications across market segments using the same credential through shared sectors.

CARRIERS - BRACELETS

CREDENTIALS | PLATFORM COMPONENTS

Contactless RFID silicone bracelets are comfortable, easy to wear and a good alternative to classic key fobs and cards. A convenient solution for commercial and industrial applications with a durable housing for rugged use or harsh environments. Attractively designed, available in various colours.



TECHNICAL CHARACTERISTICS :

- Available in 1 Kbytes / 4 Kbytes of memory
- Available in various colours.
- Meets requirements for contactless access control and compatible with SALTO Virtual Network data-on-card technology.

COLOURS:



TECHNOLOGY PLATFORMS:

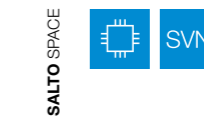

ID TECHNOLOGIES :

- MIFARE® Classic.
- Designed for multiple applications across market segments using the same credential through shared sectors.

CARRIERS - KEY FOBS

CREDENTIALS | PLATFORM COMPONENTS

Contactless RFID key fobs are a cost-effective, secure and convenient solution for commercial and industrial applications with a durable housing for rugged use or harsh environments. Attractively designed, SALTO XS4 contactless key fobs are available in various colours.



TECHNICAL CHARACTERISTICS :

- Available in 1 Kbytes / 4 Kbytes of memory
- Available in various colours, SALTO design and other design (under request).
- Meets requirements for contactless access control and compatible with SALTO Virtual Network data-on-card technology.

COLOURS:



TECHNOLOGY PLATFORMS:



ID TECHNOLOGIES :

- MIFARE® DESFire EV2.
- MIFARE® Classic.
- Designed for multiple applications across market segments using the same credential through shared sectors.

CARRIERS - KEY BRACELETS

CREDENTIALS | PLATFORM COMPONENTS

Contactless RFID key bracelets are a cost-effective, secure, easy to wear and convenient solution for commercial and industrial applications with a durable housing for rugged use or harsh environments. Attractively designed, SALTO XS4 contactless key fobs are available in various colours.



TECHNICAL CHARACTERISTICS :

- Available in 1 Kbytes / 4 Kbytes of memory
- Available in various color, SALTO design and other design (under request).
- Meets requirements for contactless access control and compatible with SALTO Virtual Network data-on-card technology.

COLOURS:



TECHNOLOGY PLATFORMS:

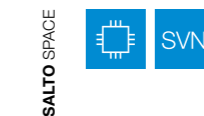

ID TECHNOLOGIES :

- MIFARE® DESFire EV2.
- MIFARE® Classic.
- Designed for multiple applications across market segments using the same credential through shared sectors.

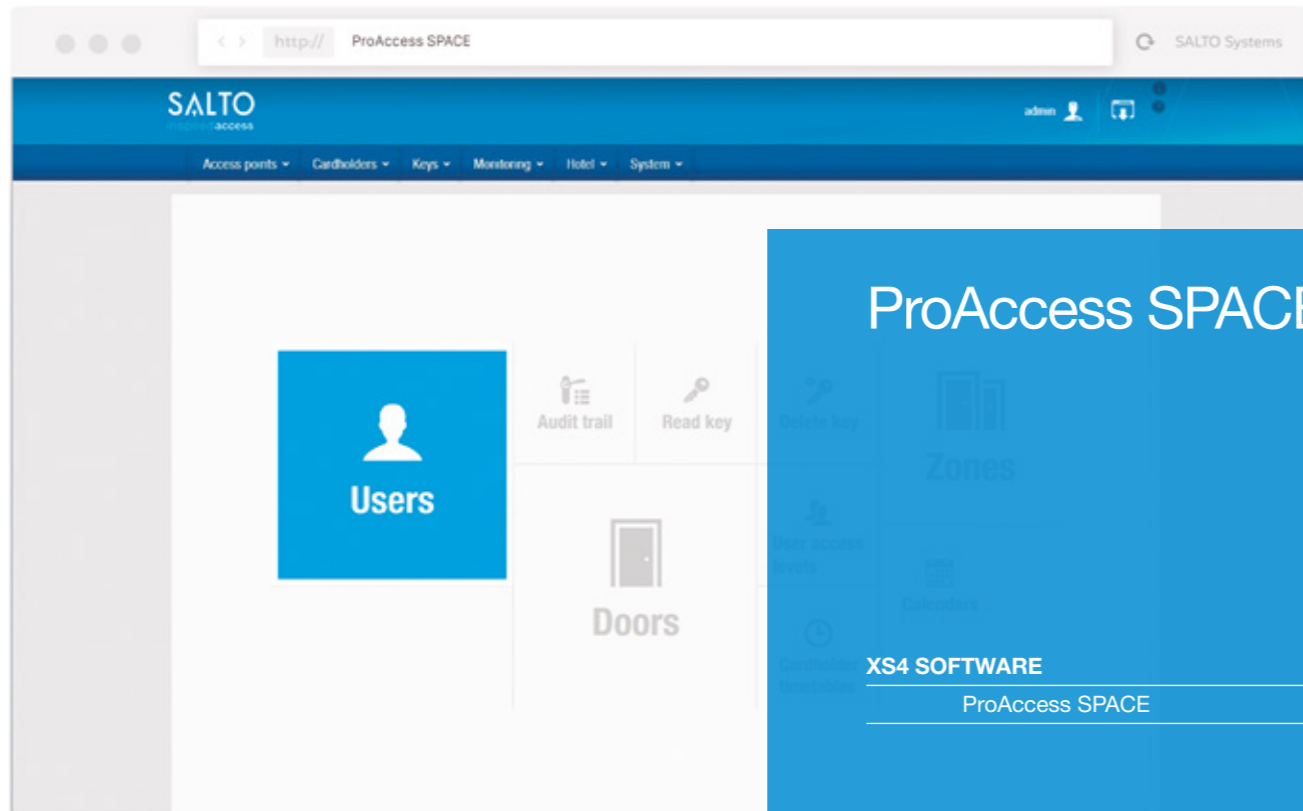

SALTO SPACE SOFTWARE | ProAccess SPACE

SALTO ProAccess SPACE Software is a powerful web-based access control management tool that enables users to program access-time zones, manage different calendars and view audit trails from each door. Its user-friendly interface is simple to

set up and configure, giving users the flexibility and control that today's modern access control systems require.

MAIN FEATURES

SERVER OPERATING SYSTEM:

- Windows 7 SP1.
- Windows 8.12.
- Windows 10.
- Windows Server 2008 R2 SP1.
- Windows Server 2012 R2.
- Windows Server 2016 (32 bit & 64 bit).

MICROSOFT .NET FRAMEWORK REQUIREMENT:

- Net Framework 4.6.2. or higher.

HARDWARE REQUIREMENT FOR SERVER:

- Processor: 1 GHz or higher. 32Bits or 64Bits.
- RAM: 4 GB.
- Hard disk space required: 10 GB. (Aprox., depends on the DB).

HARDWARE REQUIREMENT FOR CLIENT:

- Processor: 1.6 GHz or higher. 32Bits or 64Bits.
- RAM: 1 GB.
- NET framework: V.40.2

HTML5

- Supports all major web browsers like Chrome, Firefox, Edge, and Safari...

SQL DATABASE ENGINE COMPATIBILITY:

- SQL LocalDB (included in ProAccess SPACE software - SQL Server 2012 Express)
- SQL Server 2014
- SQL Server 2012
- SQL Server 2008 R2

ACCESS CONTROL FEATURES

USERS & DOORS:

- Maximum number of users per door: 4 million.
- Maximum number of doors per system: 65,000
- User access levels: Unlimited.

CALENDARS & TIME ZONES:

- Calendars in system: 256
- Time tables: 1024
- Timeperiods: 1024

ENERGY SAVING DEVICES

USER FRIENDLY:

- 100% web-based software that facilitates the setup, routine use and monitoring, as well as any updating and changing of access rights.
- Web-based interface means no need to install the software on all client PCs.
- Easy installation process that includes a powerful SQL engine. Database protected by SQL authentication or windows-based authentication.
- Multi-language and configurable interface makes it easy to adjust the interface to the specific needs and security level of each operator, including operator password protection for higher security.
- Online event monitoring through web browser permitting real-time visibility of all events at online doors.
- Incorporate user photos to facilitate easy and fast identification of users at online access points.
- Easier setup of the XS4 2.0 Controller inputs and outputs through a user friendly wizard template.

SECURE:

- Systems's auditor registers changes done by operators.
- Interface alerts to be aware of potential conflicts on the setup of the access plan or changes.
- Easy to upgrade to additional features to keep in-line with an installation's requirements.

FLEXIBLE:

- Also, an update of the server PC means that all client PCs are also updated.
- Can be managed or operated from different workstations simultaneously without risk of database corruption.
- Possibility of multi-display using different web screens.
- SALTO ProAccess SPACE software can also be used on Windows-based tablets.

SMARTPHONE-BASED:

- JustIN Mobile permits access control users and hotel guests to use their BLE-enabled smartphone as their credential.
- JustIN mSVN permits users to use their NFC-enabled smartphone to update their credentials remotely.

PROACCESS SPACE | MANAGEMENT SOFTWARE

SALTO Systems' new software, ProAccess SPACE, brings together a superior level of flexibility and functionality with an easy to use, web based interface and logic that enable the straightforward management of SALTO access control installations.

ProAccess SPACE lets users choose and pay for just the features and functions they need now, with the flexibility to upgrade accordingly in the future as their needs grow.

MAIN FEATURES

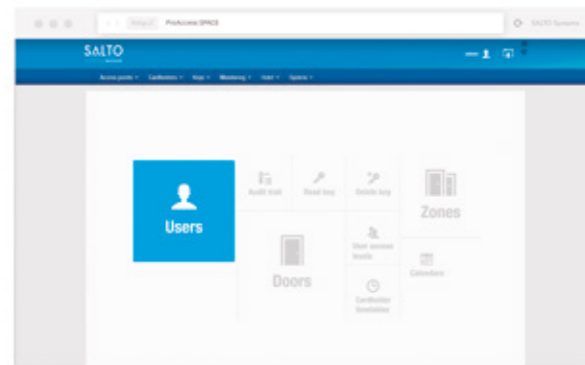

SIMPLE BUT POWERFUL IN SYSTEM SCOPE:

SALTO ProAccess SPACE gives you all the potential of one complete access control software package, whatever the size of site.

- 4,000,000 users.
- 65,000 doors, lockers, controllers...
- Unlimited user access levels.
- 1,024 zones.

THE SALTO HOST INTERFACE PROTOCOL INTERFACE (SHIP)

The SALTO Host Interface Protocol enables users to integrate their SALTO access control system to other systems, i.e., CCTV, fire alarm, traditional access control, etc., all via the same ProAccess SPACE software.

THE POWER OF AN SQL MOTOR ENGINE DATABASE MADE EASY:

Allows management of peripheral devices from your web browser, even on client workstations without any additional configuration, bringing more flexibility and convenience to your management routines.

- Reliable and secured database infrastructure (SQL authentication or Windows-based authentication).
- No complex installation or need for advanced IT department or knowledge.
- No expensive licenses.
- Suitable for high security installations that require compliance with the highest IT standards.
- SSL protocols to warranty the security.
- Encrypted communication between the software and SALTO devices.

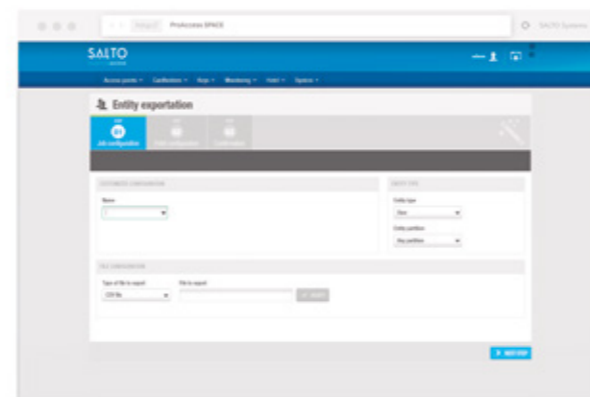

MOBILE ACCESS CONTROL WITH SALTO JUSTIN MOBILE:

SALTO's new ProAccess SPACE software enables users to the benefit of SALTO Mobile technology through Justin mSVN or Justin Mobile. Both of these mobile solutions bring better security and usability to end users as well as system managers.

End users gain convenience and productivity without sacrificing security, while facility managers distinguish their property with cost-effective solutions that clients truly value.

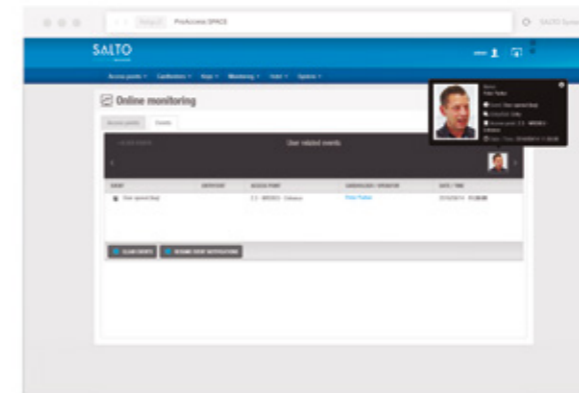

USER-CENTERED INTERFACE DESIGN:

SALTO ProAccess SPACE has been designed to meet the needs of all of our users, providing an efficient tool that makes their daily tasks easier, faster and more productive.

- More intuitive and user-friendly interface, with one window from which an operator manages all the tools needed.
- Multi-windows interface.
- Multi-language interface.
- Interface alerts of potential conflicts in the setup of access plan or changes.

COMPATIBLE WITH MULTIPLE BROWSERS AND OS:

SALTO ProAccess SPACE software client interface works with Microsoft Explorer, Safari and Firefox and can also be used with Windows tablets. Just a Silverlight plug-in needs to be installed and that's it.

CUSTOMISE OPERATOR PROFILES, INCLUDING SECURITY LEVELS:

Operators are in control of the access plan management, so that's why ProAccess SPACE has a lot of functionality around operator management.

- Customization of the operator profile and operator workspace.
- Operator password protection for higher security.
- System auditor to track what changes have been made by which operators.

MULTI-WORKSTATION WITHOUT MULTI-STATION DESKTOP INSTALLATION:

SALTO's web-based interface means the system can be managed or operated from different workstations simultaneously without risk of database corruption.

No need to install the software on all operator PCs. Simply install SALTO ProAccess SPACE SERVICE on one server or computer, then give access to other authorised computers inside the network.

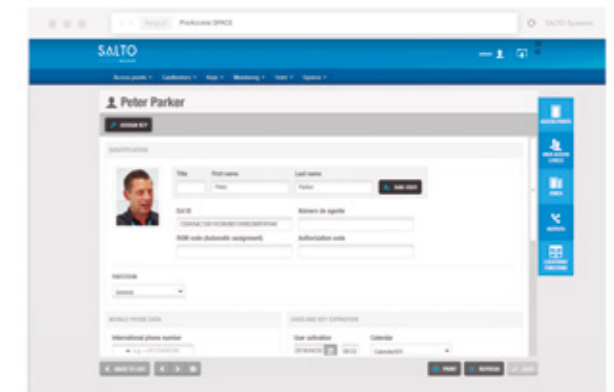

BUY EXACTLY WHAT YOU NEED ONCE, AND EASILY ADD ON A LA CARTE AS YOUR REQUIREMENTS GROW:

SALTO ProAccess SPACE Software builds upon the experience and functionalities of ProAccess while adding an impressive mix of new capabilities and usability.

- Licensing system allows adding features and creating a tailor-made system, depending on your needs.

UPGRADABLE:

Migrating from existing SALTO software is straightforward, no matter the version of ProAccess or HAMS currently in use.

You can upgrade while maintaining all the content of the access plan, users, doors, audit trail, etc.

PROACCESS SPACE | MANAGEMENT SOFTWARE

ProAccess SPACE lets users choose and pay for only the features and functions they need now, with the flexibility to upgrade accordingly in the future as their needs grow.

With the SALTO ProAccess SPACE perpetual license system, you pay once for the features you need, and if new needs arise, you can easily and quickly upgrade your license, increasing the functionality and with the convenience you need.

MAIN FEATURES



Interfacing

Monitoring



EVENT STREAM:

The Event Stream option generates real-time notifications to third party systems. The idea is to filter the audit trail and send the selected events so that the order system can process the received information and perform a real-time action.

Feature included in: SPAONLINE, SPAIDSYS and SPAPART packages.



SHIP INTEGRATION:

The SALTO Host Interface Protocol enables users to integrate their SALTO Access Control system with other systems i.e., CCTV, fire alarm, traditional access control, etc., all via the same software.

Function is only available as a separate add-on and is not included in any predefined package.



SALTO MOBILE USERS:

SALTO Mobile permits registered users to use their BLE-enabled smartphone as their credential, or their NFC-enabled smartphone to serve as a remote updating point to keep their access rights always up to date. ProAccess SPACE software permits the specific selection of which mobile solution -- JustIN Mobile or JustIN mSVN -- is appropriate for each individual user.

Function is only available as a separate add-on and is not included in any predefined package.



OPERATORS PROFILE:

Each system operator can customize the look and feel of its own GUI by pre-defining the language, which encoder is to be used, column sorting etc., allowing a more efficient multi-user environment.



ONLINE MONITORING:

SALTO ProAccess software enables you to monitor in real-time not just battery status or if an update is needed, but also who accessed what door and when, if a door has been left open, intrusions, etc. Total control, all in real-time.

Feature included in: SPABASIC, SPAONLINE, SPAIDSYS and SPAPART packages.



LIMITED OCCUPANCY:

Using the Limited occupancy feature, you can control the maximum number of authorised users. The system will automatically deny access once set occupancy levels are reached, re-granting access if or when the limits are reset.

Feature included in: SPAONLINE, SPAIDSYS and SPAPART packages.



ROLL CALL:

Through the Roll Call function, you can track where users are in different roll call areas in real-time.

Feature included in: SPAONLINE, SPAIDSYS and SPAPART packages.



GRAPHICAL MAPPING:

Graphical mapping is a visual interface that permits monitorization of users' access to online wired and wireless access points in real-time throughout the building layout.

Function is only available as a separate add-on and is not included in any predefined package.

Advanced security

Administrator



LOCKDOWN:

SALTO ProAccess SPACE software enables users to make an emergency lockdown of a property in the event of a security incident.

Feature included in: SPAONLINE, SPAIDSYS and SPAPART packages.

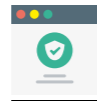

AMOK:

SALTO AMOK electronic escutcheons have a built-in card reader on the inner escutcheon that enables users to activate the AMOK function mode in order to lock down a room quickly. Only authorized users with AMOK privileges on their access plan can activate it.

Feature included in: SPABASIC, SPAONLINE, SPAIDSYS and SPAPART packages.



MATRIX FUNCTIONS AND LOCATIONS:

The combination of users to doors and their different functions can cause occasional keying problems when designing the access plan. The Matrix Access Function simplifies and streamlines the link between users and doors, making access planning simple and straightforward.

Function is only available as a separate add-on and is not included in any predefined package.

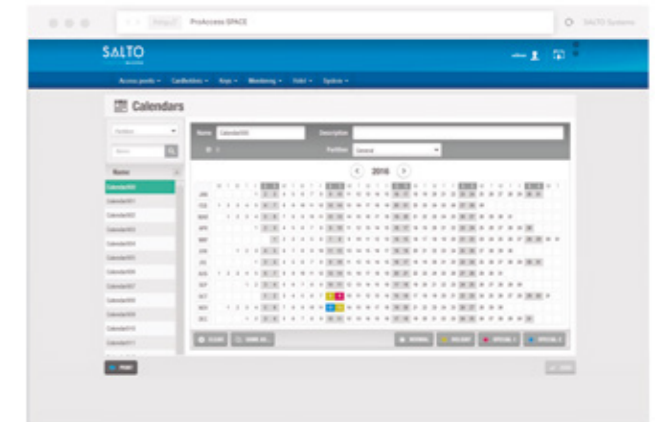

ANTIPASSBACK:

The Antipassback feature establishes a specific sequence in which access cards must be used in order for the system to grant access.

Feature included in: SPAONLINE, SPAIDSYS and SPAPART packages.

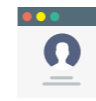
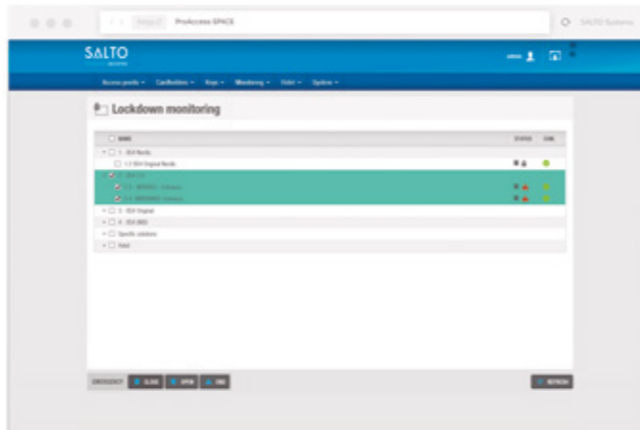

VISITOR MANAGEMENT:

The Visitor module enables you to issue visitor cards for a few hours, a few days or for something in between, and all with a built-in cancellation date that will disable the credential automatically. Visitor management system module lends a more flexible and efficient check-in & check-out system, enhances security and meets compliance mandates for the collection and auditing of visitor data.

Feature included in: SPAIDSYS and SPAPART packages.

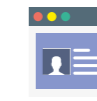

BADGING:

The SALTO badging module enables users to create templates for card credentials via information from the user's access plan data. The cards can be customized both internally and externally.

Feature included in: SPAIDSYS and SPAPART packages.



AUTOMATIC KEY ASSIGNMENT:

Automatic key assignment is a tool that enables the encoding of key cards directly via a wall reader at the main point of access. This can be done the first time a user presents their card, saving time and the need to queue for card validation.

Feature included in: SPAONLINE, SPAIDSYS and SPAPART packages.



EVENT ENGINE MODULE:

SALTO ProAccess SPACE can now manage specific event-triggered actions and alarms. The Event Engine's intuitive wizard permits programming of any event audit trail or any event-triggered action through the CU42xxx inputs to automatically perform defined actions, such as activating CCTV recording, sending e-mail alert notifications, activating lockdown, etc.

An event can be scheduled or triggered by a user, user group or door event through an audit trail event or XS4 2.0 Controller inputs.

Function is only available as a separate add-on and is not included in any predefined package.



LOCKER LOCKS:

As part of the SALTO platform, our XS4 locker locks can also be managed through ProAccess SPACE software. This provides an impressive range of options including free assignment mode, family mode, subject to calendars, etc.; almost unlimited possibilities.

Feature included in: SPABASIC, SPAONLINE, SPAIDSYS and SPAPART packages.



PARTITIONS:

Department operator enables properties to be managed independently but while retaining shared access privileges. Individual buildings can be run by their own managers, controlling their own user's access rights.

Feature included in: SPAPART packages.

PROACCESS SPACE | FRONT DESK MANAGEMENT SOFTWARE

For the Hospitality market, SALTO has developed specific Add-ons which allow hotel clients to easily control all their access and guest management needs with one easy-to-use system. It suits hotels of all types and sizes.

These plus other key hotel features make it easy to control all the offline and online guest rooms and back-of-house doors from one central location.

HOSPITALITY ADD-ONS

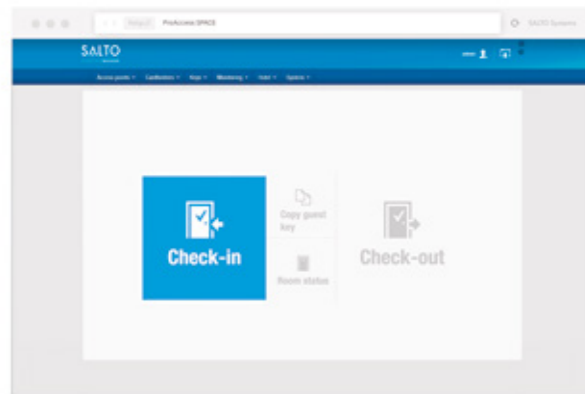

GROUP CHECK-IN:

When guests arrive at a hotel, they want to check in and get started on what they came to do: hang back and relax, or start in on work. That means that all the steps of the check in process need to work flawlessly, from issuing the guest card to guests being able to seamlessly access their room, pool area, spa or other amenities.

With ProAccess SPACE a fast group check-in is possible, which allows hotel clients to easily control all their access and guest management needs with one easy-to-use system.

REAL-TIME RE-ROOMING / EXTENDED STAY:

Display what's happening around your hotel and take control from the guest room to the rest of your property access points (Back-of-house and guest service doors) in one single system providing security and reliable access control 24/7 that covers the entire property.

SALTO ProAccess SPACE allows the guest to extend their stay or request a room change without having to visit reception, as almost instant re-rooming is enacted and the guest's access credentials will give them immediate entry to their new room with better views.

MOBILE ACCESS (BLE):

Provide your guests with a hotel experience they value and want to repeat by facilitating their check-in experience without sacrificing their security and comfort.

With ProAccess SPACE it's easy to incorporate mobile access control. Visiting the front desk will soon be a thing of the past with SALTO's revolutionary innovation in guest experiences. Guests can now access their hotel room and bypass the front desk by using their smartphone as a room key; check out without having to return keys; and extend their stay simply by requesting an extension via their phone. Can be used along with or as a replacement of RFID credentials.

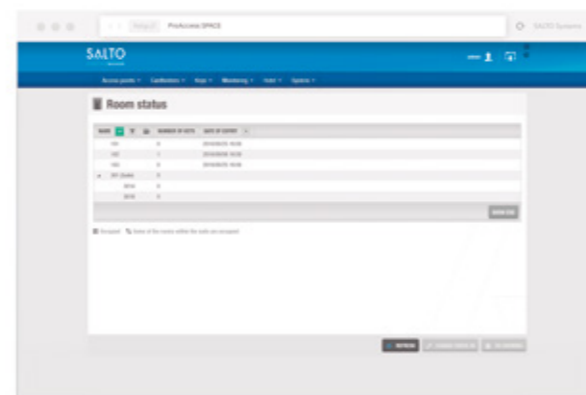

PROPERTY MANAGEMENT SOFTWARE (PMS)

ProAccess SPACE is compatible with leading property management software (PMS) such as Micros FIDELIO, New Hotel, Protel, Infor, etc., to validate guest registrations, guide the guest through the check-in/out process and generate guest room keys. Can also be used to manage SALTO Intelligent Energy Saving Devices (ESD).

SOFTWARE PACKAGES GUIDE/INFORMATION

SALTO's ProAccess SPACE web-based software brings a new level of powerful flexibility to access control so that users can order the functionalities that they most need and upgrade accordingly as a system and needs grow. And in addition to the abundance of important new functionalities, SPACE also has a modern interface

that is more user-friendly to help users find and operate the functions they want to use as quickly and intuitively as possible.

	— SPABASIC	— SPAONLINE	— SPAIDSYS	— SPAPART
USERS	4,000,000	4,000,000	4,000,000	4,000,000
DOORS	65,000	65,000	65,000	65,000
EXPIRATION PERIOD	NO EXPIRATION	NO EXPIRATION	NO EXPIRATION	NO EXPIRATION

FUNCTIONS

	OPT-No.	— SPABASIC	— SPAONLINE	— SPAIDSYS	— SPAPART
LOCKER	0001	INCLUDED	INCLUDED	INCLUDED	INCLUDED
ONLINE MONITORING	0004	INCLUDED	INCLUDED	INCLUDED	INCLUDED
LOCKDOWN	0005	NOT INCLUDED	INCLUDED	INCLUDED	INCLUDED
ANTIPASSBACK	0006	NOT INCLUDED	INCLUDED	INCLUDED	INCLUDED
EVENT STREAM	0007	NOT INCLUDED	INCLUDED	INCLUDED	INCLUDED
AUTOMATIC KEY ASSIGNMENT	0008	NOT INCLUDED	INCLUDED	INCLUDED	INCLUDED
ROLL CALL	0009	NOT INCLUDED	INCLUDED	INCLUDED	INCLUDED
LIMITED OCCUPANCY	0010	NOT INCLUDED	INCLUDED	INCLUDED	INCLUDED
VISITOR MANAGEMENT	0013	NOT INCLUDED	NOT INCLUDED	INCLUDED	INCLUDED
BADGING MODULE	0012	NOT INCLUDED	NOT INCLUDED	INCLUDED	INCLUDED
DEPARTMENT OPERATOR	0011	NOT INCLUDED	NOT INCLUDED	NOT INCLUDED	INCLUDED



SALTO KS Platform components

SALTO KS PLATFORM COMPONENTS

IQ

Tags

Mobile App

SALTOKS.com

SALTO KS | CLOUD-BASED LOCKING SOLUTION

The SALTO KS - Keys a a Service - platform is more than just a locking solution, and by combining the locks with other devices, we can reach a level of convenience and performance higher than the traditional stand-alone access control systems.

IQ

The IQ is the center of the SALTO KS solution. It connects your wireless locks to the SALTO KS cloud. Mount the IQ with the included bracket, plug it into the power outlet and activate it in your saltoks.com account.

The SALTO KS Repeater allows you to extend the distance between the SALTO KS IQ and your locks. IQ and locks can be 1–10 metres apart, but each time you add a Repeater you extend this by 10 metres. You may add 3 repeaters in between an IQ and a lock which means that maximum distance between door and IQ can be up to 40 metres.

MOBILE APP

Manage SALTO KS on-the-go! Available for iOS and Android phones the SALTO KS App enables you to manage the access control system when you are on-the-go and in real-time. It offers those features that you want to be able to use whenever and wherever.



TAGS

The SALTO KS tag is the smallest of the SALTO KS family but highly secure and just as good-looking. The heart of the tag holds the most secure RFID chip available in the market to make sure that it is impossible to duplicate the tag ID.

SALTOKS.COM

The SALTO KS account allows you to define who goes where and when in a building. Create profiles for users, assign or block tags, define which doors they may enter on which days, at which times.

IQ

SALTO KS IQ | CLOUD-BASED LOCKING SOLUTION

The IQ 2.0 uses 2G, 3G and 4G cellular connectivity to communicate with the SALTO cloud. Also available in WiFi or POE version and always available through Ethernet connection. The IQ 2.0 communicates with SALTO KS access points via ZigBee/Bluetooth.



TECH SPECS:

- Operation conditions:**
 -Temperature: 0-40°.
- 2,4Ghz RF Characteristics:**
 -Frequency Range: 2405-2480Mhz (ISM band).
 -RF Standard: IEEE 802.15.4.
 -Indoor Radio Range: 10/15m.
- GPRS RF Characteristics (SALTO KS IQ only):**
 -Frequency bands:
 - EGSM-GPRS 900/850 radio.
 - GSM-GPRS 1800/1900 radio.
 - EGPRS 900/850 radio.
 - EGPRS 1800/1900 radio.
 - GSM/GPRS class 10 and EGPRS class 10 capable.
- Power supply characteristics
 (Only for use with SALTO KS's power supply)**
 - Input voltage: 12v.
 - Max current: 800 mA.

PRODUCT ATTRIBUTES:

- **It always fits.** The SALTO KS IQ bracket adapts to your situation. Mount it horizontally or vertically, whatever suits best.
- **LED notification.** This means that besides through home.saltoks.com messaging, also a visual notification on the device itself will inform you about the well-being of your SALTO KS system. Turn off "Heartbeat" green light on IQ if you prefer.
- **Extend distances.** Add up to 3 SALTO KS Repeaters in line and a maximum of 6 for each SALTO KS IQ between your access point and the SALTO KS IQ.

FEATURES:

- Wireless radio frequency based on IEEE 802.15.4 at 2,4Ghz.
- AES 128bits encryption.
- Online in real-time communication.
- Connectivity in +100 countries.
- Matching adapter included with 3 meter cable.
- Over the Air (OTA) firmware updates.
- TLS secured communication.
- No data outage risk through best roaming guarantee.
- Connects up to 16 doors per SALTO KS IQ.
- Unlimited SALTO KS IQs per account.
- Cellular connection 2G, 3G, 4G.
- Local Access Management (LAM).

TECHNOLOGY PLATFORMS:



TECHNICAL DRAWING:

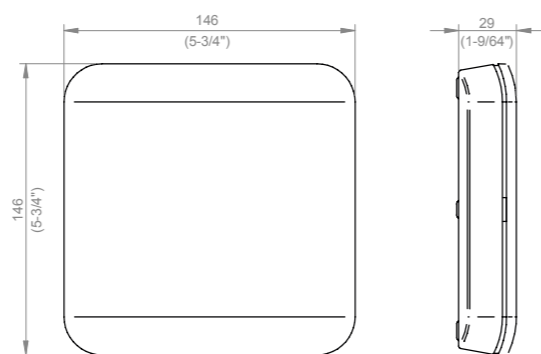

CERTIFICATIONS:



TAGS

SALTO KS TAGS | CLOUD-BASED LOCKING SOLUTION

The SALTO KS tag is the smallest member of the SALTO KS family but highly secure and just as good-looking. The heart of the tag holds the most secure RFID chip available in the market to make sure that it is impossible to duplicate the tag ID.



ID TECHNOLOGIES

- DESFire EV2 4K (4096 bytes).
- DESFire EV2 + SVN compatible.
- Dual Tag available: DESFire EV2 + EM4200 125 kHz chip.
- Dual Tag + SVN compatible.

PRODUCT ATTRIBUTES:

- **Adding tags.** To add tags, just select one of your doors and use the secured 2 minute window to present them at the lock.
- **Blocking tags.** In case someone has lost or did not return one of your tags you simply block them via My-SALTO KS. Blocking is real-time without any delay and when you retrieve a tag you simply unblock it.
- **Security.** You can add any SALTO KS tag to your system but once they are added, they belong to that system. The RFID technology used is the same as in many governmental and military applications and uses AES algorithm.
- **1 Tag : 5 colours.** No one is alike and SALTO KS understands. That's why the tag will be available in 5 different colours.

FEATURES:

- SALTO KS tags meet ISO Standards.
- Battery-free operation.
- Choice of 5 colours.
- Waterproof.
- 13,56 Mhz.
- Single SALTO KS tag works for multiple SALTO KS systems.
- Secure, copy-proof data carrier for high security.
- Strong, ergonomic design for long life.
- High resistance to variations in weather conditions.
- Comfortable to use - can be carried on a key ring alongside traditional keys.
- SALTO SVN compatible.
- Dual tag available. EM4200 125 kHz chip - Read Only.

TECHNOLOGY PLATFORMS:



COLOURS:



MOBILE APP

SALTO KS APP | [CLOUD-BASED LOCKING SOLUTION](#)

Manage SALTO KS on-the-go! Available for iOS and Android phones the SALTO KS app enables you to manage the access control system when you are on-the-go and in real-time. It offers those features that you want to be able to use whenever and wherever.



PRODUCT ATTRIBUTES:

- **Remote Opening.** One of the cool but really functional features of SALTO KS is the remote opening of doors with secure one-time-password technology. You may not use it everyday but when you need it, you will be happy it's there.
- **Multiplatform.** You can manage SALTO KS cloud-based access control from any device – phone, tablet, PC- all you need is an online device with an Internet connection.
- **Reliability.** Ensuring real-time monitorization and solving any issues caused immediately.

MOBILE APP AVAILABLE FROM:



WEB APPLICATION

SALTOKS.COM | [CLOUD-BASED LOCKING SOLUTION](#)

The SALTO KS account allows you to define who goes where and when in a building. Create profiles for users, assign or block tags, define which doors they may enter on which days, at which times.

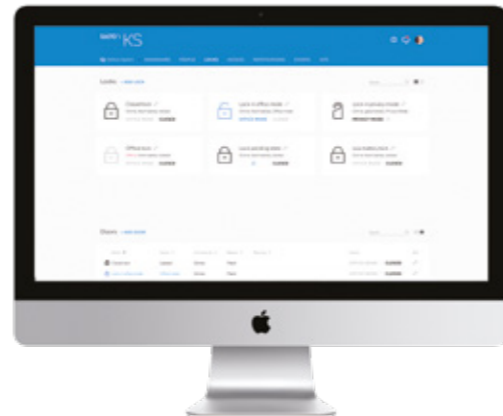

PRODUCT ATTRIBUTES:

- **The Dashboard.** Saltoks.com always gives you up-to-date information and remote management of all users and access points through the dashboard.
- **Access rights, who, where, when...** What no conventional key can do is change access rights on the fly. Saltoks.com gives you the opportunity to individually determine who enters when and where. And if you want to change that, just log-in, make your changes and it's done. No updating of tag or access point required. Have you ever been able to do this with your current lock?
- **Messaging.** Saltoks.com always gives you up-to-date information and remote management of all system components through the dashboard. It's all there: door status, last entries and events, alarms and the possibility to open and lock doors remotely.
- **Security.** SALTO understands the importance of security. That's why we have incorporated state-of-the-art security measures in all our components and more importantly, we will keep updating that permanently. Not always visible but always there.
- **Multiplatform.** You can manage SALTO KS from any device – phone, tablet, PC - all you need is an online device with an Internet connection.

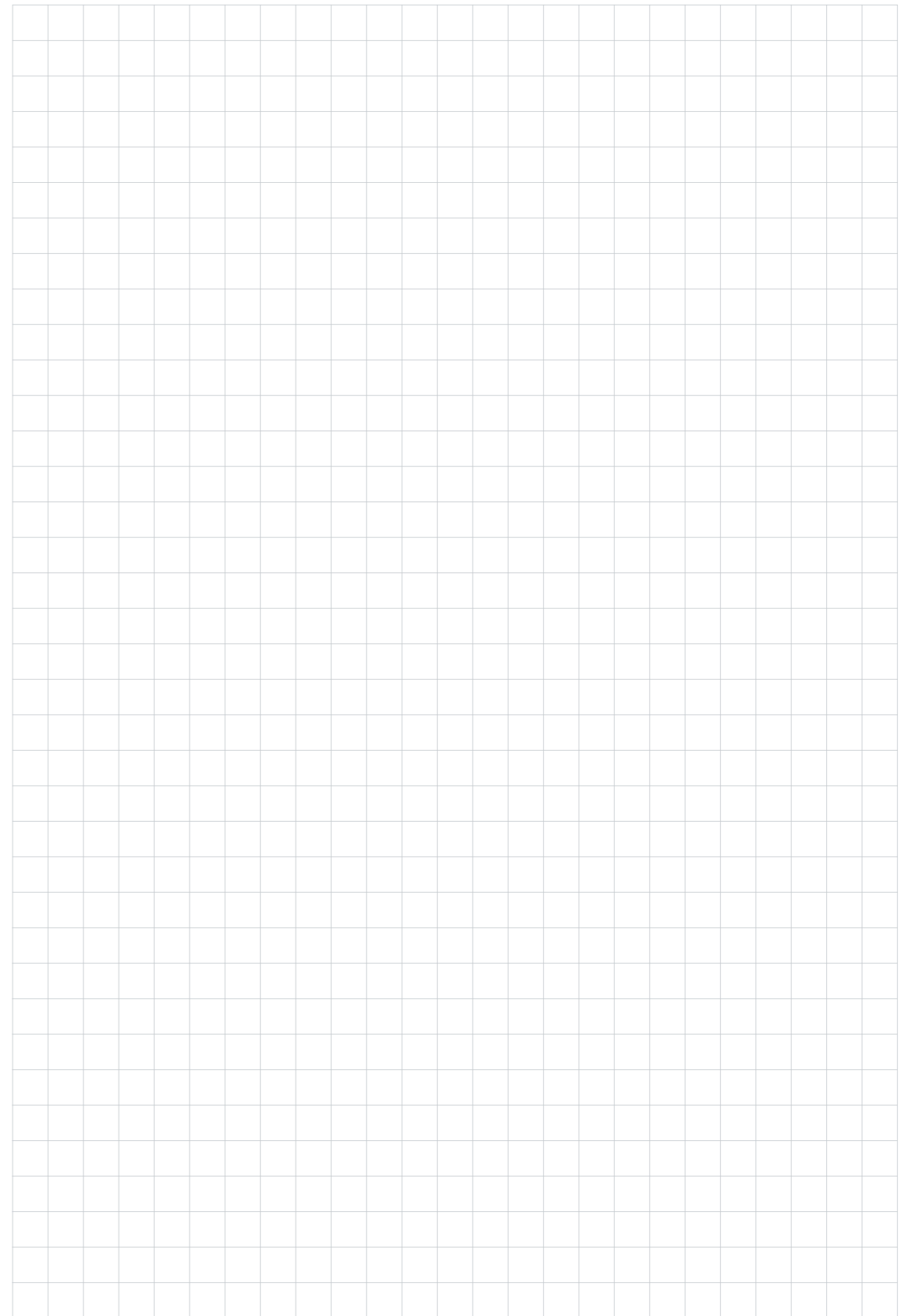

SALTO KS Connect

SALTO KS CONNECT
CameraManager



CAMERAMANAGER

SALTO KS CONNECT | CLOUD BASED VIDEO SURVEILLANCE

Eagle Eye CameraManager is built for the cloud, providing reliability and safety. It's ideal for servicing multiple locations and provides access to live and recorded video, from one or more locations, with a single login. And fully integrated in the SALTO KS app.

TECH SPECS:

- INDOOR MODEL:**
- HD video 1080p
 - Motion, infrared and sound detections
 - Microphone
 - Wide angle view (95°)
 - Night view up to 10m
 - SD card
 - Wifi

- OUTDOOR MODEL:**
- IP67 outdoor
 - HD video 1080p
 - Motion detections
 - Power over ethernet
 - Wide angle view (93°)
 - Night view up to 30m



PRODUCT ATTRIBUTES:

- **Easy set-up:** Add cameras in two steps.
- **Scheduling:** Record when needed.
- **Notifications:** Know what's up.
- **Live Streaming:** See who's in front of the door.
- **Event Recordings:** Look back in time.

HOW DOES IT WORK?

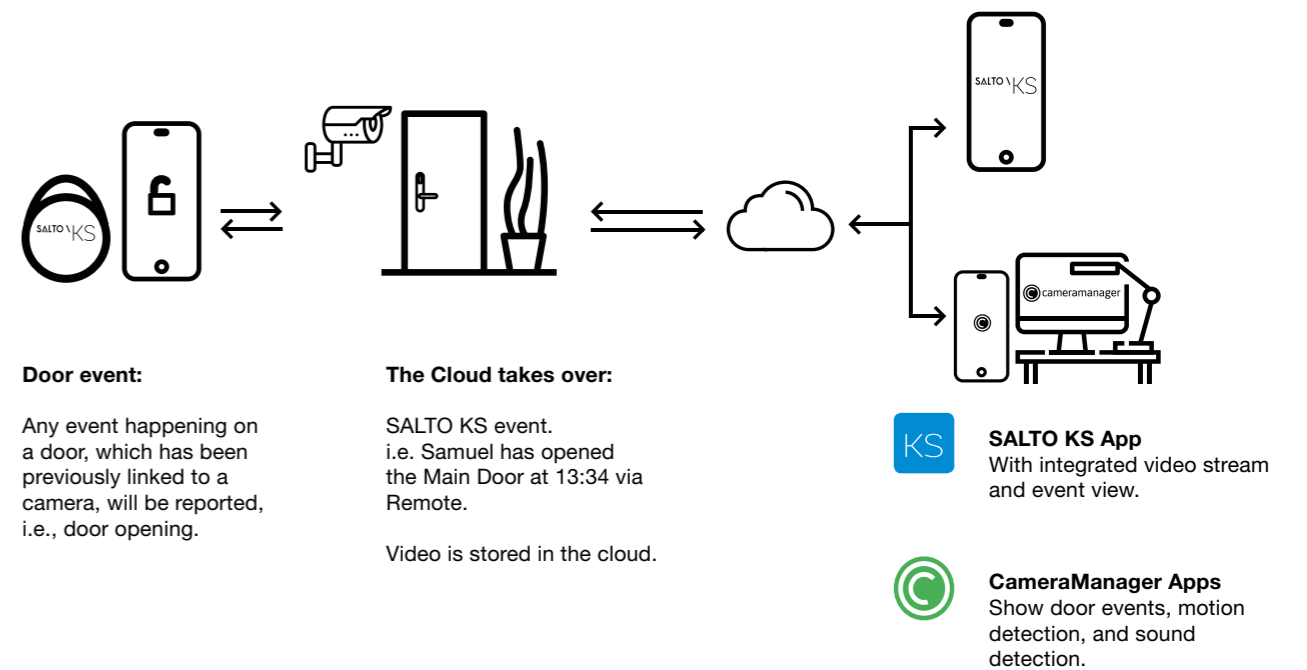

TECHNOLOGY PLATFORMS:



BUILD YOUR OWN DOOR

CUSTOMIZE YOUR ELECTRONIC DOOR LOCK

Select an electronic lock model, door type and customize your SALTO door lock with a range of colours, finishes and handle options.

This innovative tool will allow for complete visualization and customization of the locking solutions chosen by the user. By accessing the web page, the user is able to select the door lock model online to configure and create a customized door by personalizing everything.

SALTO continues to innovate by launching a unique tool for the access control industry.

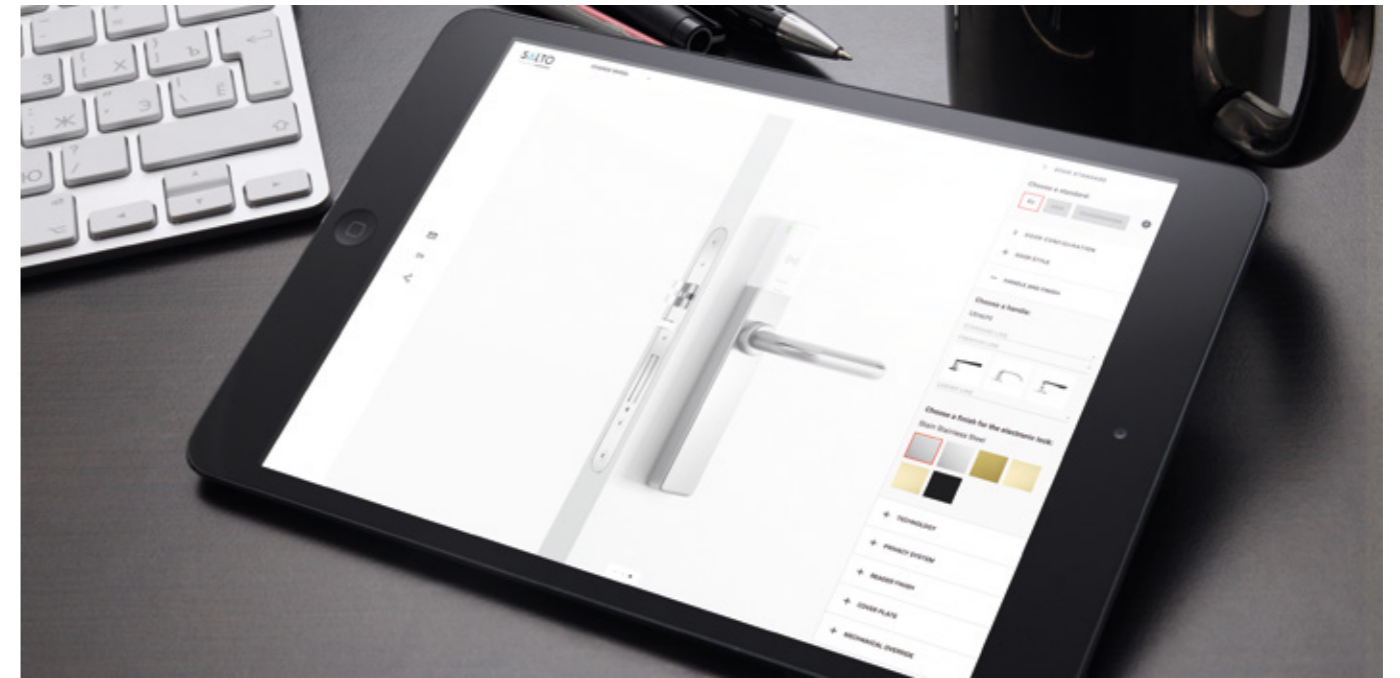

<https://mylock.saltosystems.com>



CHOOSE YOUR ELECTRONIC LOCK MODEL:

Choose your favorite electronic lock model (ANSI, Euro or Scandinavian standards) to create your customized door and personalise everything.

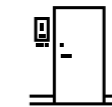

CHOOSE YOUR DOOR TYPE AND SELECT A HANDLE DESIGN:

Choose a door type, finish, handle design and lockset finish that match your door.



DOWNLOAD AND SAVE YOUR SETTINGS:

Once the door configuration is complete, you can store and compare it against previously-configured door lock models or save it as a PDF.



CONTACT US:

Send us your selection, ask us a question or just contact us for a demo.

ABOUT US

SALTO Systems revolutionized access control with the introduction of the SALTO Virtual Network SVN data-on-card technology and the battery-operated wire-free electronic lock range in 2001. For nearly 20 years SALTO has been synonymous with innovative solutions, including stand-alone, cloud-based and mobile applications, that set new standards in security, manageability, flexibility and design that bring real-world benefits to virtually any type of door. Across a broad range of industries and applications, SALTO is widely recognized as a global market leader in electronic access control solutions.

OUR COMMITMENT TO BEST SERVICE

To ensure we deliver the very best possible service, SALTO needs to be where our customers are.

This is why SALTO has its own offices in Australia, Belgium, Canada, China, Colombia, Czech Republic, Denmark, France, Finland, Germany, Hong Kong, Italy, Mexico, The Netherlands, Norway, Poland, Portugal, Singapore, Slovak Republic, Spain, South Africa, Switzerland, UAE, UK and USA.

Our office network will continue to grow to make certain that SALTO provides unrivalled levels of warranty support and service.

SALTO PARTNER NETWORK

As well as our SALTO offices, we also have a specialized partner network in over 90 countries.

These offices count on expertise from specialists in the security industry who share the same values of enthusiasm and commitment as SALTO, and who are ready to provide customers with the very best support and service.

SALTO's official partners are all security specialists.

THE ACCESS CONTROL PARTNER YOU CAN RELY ON

At SALTO we have all key activities in-house, from product conception and design, right up through the final manufacturing and shipping processes.

This continuity allows SALTO to warranty our products to the highest quality standards, thereby giving our customers the flexibility, delivery and peace of mind they require.

At SALTO, we believe this type of direct control best enables us to continue to develop, launch and support the most effective access control solutions available.

SALTO is ISO 9001:2015 and ISO 14001 certified, demonstrating that rigorous quality and environmental management systems are in place to ensure the design, development and manufacture of our electronic access control products always strive to achieve the highest possible standards in quality, as required by our customers.

SOCIAL RESPONSIBILITY (CSR)

SALTO Systems takes very seriously its responsibility to play a leading role in the social development of the local community around its many offices throughout the world.

In 2005 this effort was channelled into creating the free2move.org social initiative that works to promote handicapped sport as a means of achieving greater social integration, and thereby defying the assumption that people with a physical disability cannot lead a life of excellence and achievement.

www.free2move.org

Find us on Facebook - Instagram - Twitter & YouTube



The access control company you can rely on.
www.saltosystems.com



SALTO Systems HQ, Spain
Oartzun / Madrid Spain

Tel.: +34 943 344 550
email: info@saltosystems.com
www.saltosystems.com

SALTO Systems, UK
Southam, United Kingdom

Tel.: +44 01926 811979
email: info.uk@saltosystems.com
www.saltosystems.co.uk

SALTO Systems, USA
Norcross GA / New York NY, USA

Tel.: +1 770 452 6091
email: info.us@saltosystems.com
www.salto.us

SALTO Systems, Canada
Vaudreuil-Dorion QC, Canada

Tel.: +1 514 616 2586
email: info.ca@saltosystems.com
www.saltosystems.ca

SALTO Systems, Mexico
Cancún, México

Tel.: +52 (998) 892 8752
email: info.mx@saltosystems.com
www.saltosystems.co.mx

SALTO Systems, Colombia
Bogota, Colombia

Tel.: +57 320 924 3634
email: info.co@saltosystems.com
www.saltosystems.com

SALTO Systems, Australia
Notting Hill, Victoria, Australia

Tel.: +61 (0)3 8683 9782
email: info.au@saltosystems.com
www.saltosystems.com.au

SALTO Systems, Middle East
Dubai, United Arab Emirates

Tel.: +971 4399 5770
email: info.me@saltosystems.com
www.saltosystems.com

SALTO Systems, France
Nanterre, France

Tel.: +33 (0)1 55 17 13 70
email: info.fr@saltosystems.com
www.saltosystems.fr

SALTO Systems, Germany
Wuppertal, Deutschland

Tel.: +49 (0)202/ 769 579-0
email: info.de@saltosystems.com
www.saltosystems.de

SALTO Systems, Switzerland
Eschlikon, Switzerland

Tel.: +41 71 973 72 72
email: info.ch@saltosystems.com
www.saltosystems.ch

SALTO Systems, Netherlands
Amsterdam, The Netherlands

Tel.: +31 206 353 100
email: info.nl@saltosystems.com
www.saltosystems.nl

SALTO Systems, Belgium
Brussels, Belgium

Tel.: +32 25 88 50 68
email: info.be@saltosystems.com
www.saltosystems.be

SALTO Systems, Poland
Warszawa, Polska

Tel.: +48 609 01 7777
email: info.pl@saltosystems.com
www.saltosystems.pl

SALTO Systems, Slovakia
Bratislava, Slovakia

Tel.: +421 915 579 500
email: info.sk@saltosystems.com
www.saltosystems.com

SALTO Systems, Czech Republic
Prague, Czech Republic

Tel.: +420 734 258 882
email: info.cz@saltosystems.com
www.saltosystems.com

SALTO Systems, Denmark
Kalundborg, Denmark

Tel.: +45 48 44 88 11
email: info.dk@saltosystems.com
www.saltosystems.dk

SALTO Systems, Norway
Råholt, Norway

Tel.: +47 63 95 40 20
email: info.no@saltosystems.com
www.saltosystems.no

SALTO Systems, Sweden
Stockholm / Malmö, Sweden

Tel.: +46 8-775 87 00
email: info.se@saltosystems.com
www.saltosystems.se

SALTO Systems, Finland
Vantaa, Finland

Tel.: +35 48 44 88 11
email: info.fi@saltosystems.com
www.saltosystems.fi

SALTO Systems, Italy
Bologna, Italy

Tel.: +39 051 72 77 98
email: info.it@saltosystems.com
www.saltosystems.it

SALTO Systems, Portugal
Lisbon / Porto, Portugal

Tel.: +351 220 937 508
email: info.pt@saltosystems.com
www.saltosystems.com

SALTO Systems, Singapore
Singapore

Tel.: +65 6557 22 55
email: info.sg@saltosystems.com
www.saltosystems.com

SALTO Systems, China
Shanghai, China

Tel.: +86 (21) 3157 6115
email: info.cn@saltosystems.com
www.saltosystems.com

SALTO Systems, Hong Kong
Hong Kong

Tel.: +852 3169 1820
email: info.hk@saltosystems.com
www.saltosystems.com

SALTO Systems, South Africa
Johannesburg, South Africa

Tel.: +27 (80) 87 701 5858
email: info.za@saltosystems.com
www.saltosystems.com

